

1/2

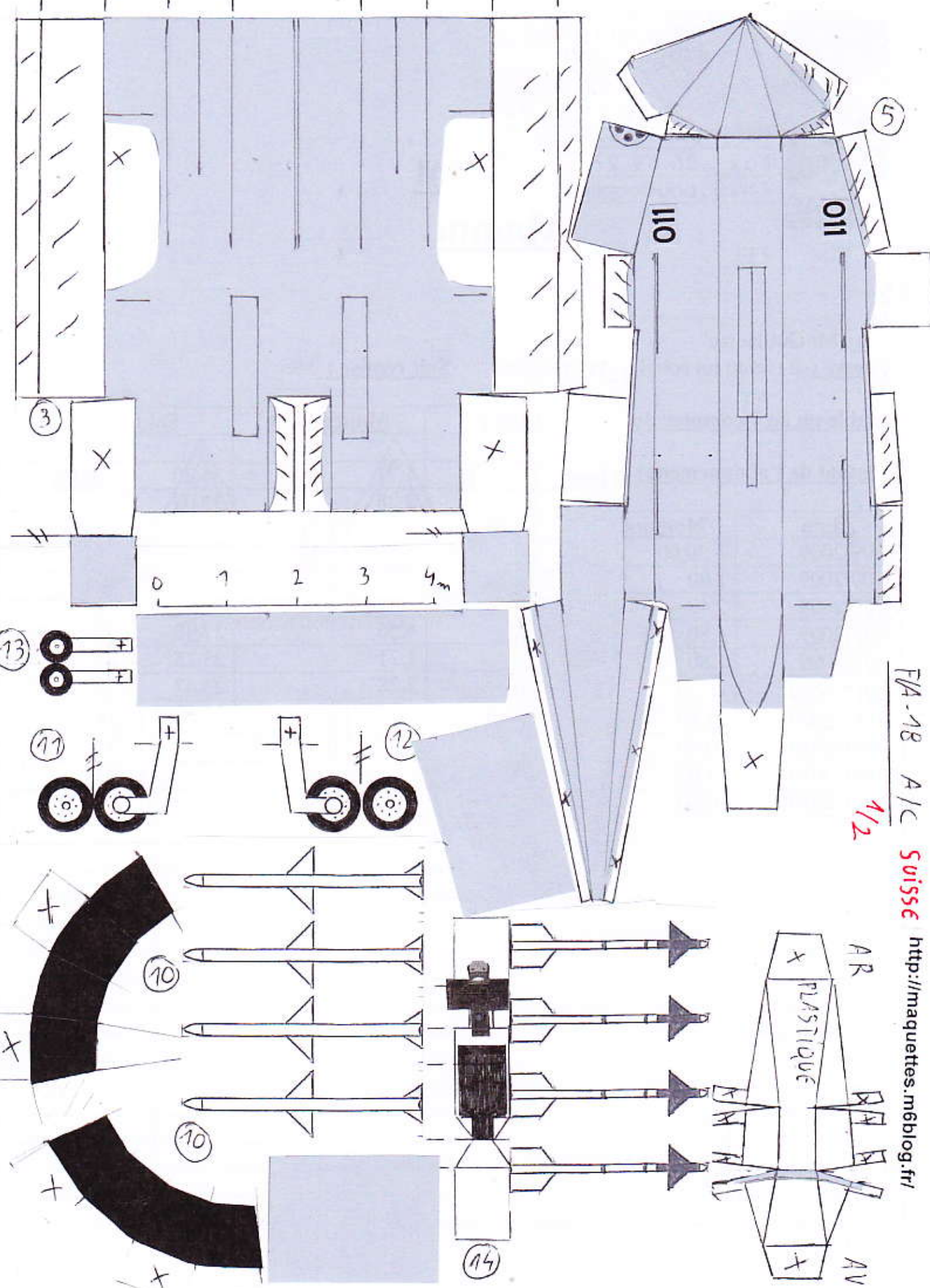

SUISSE 2/2

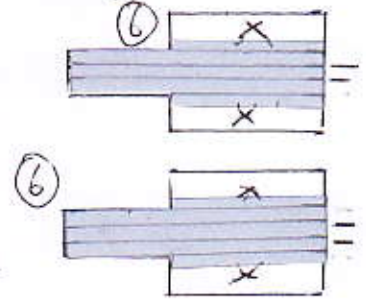

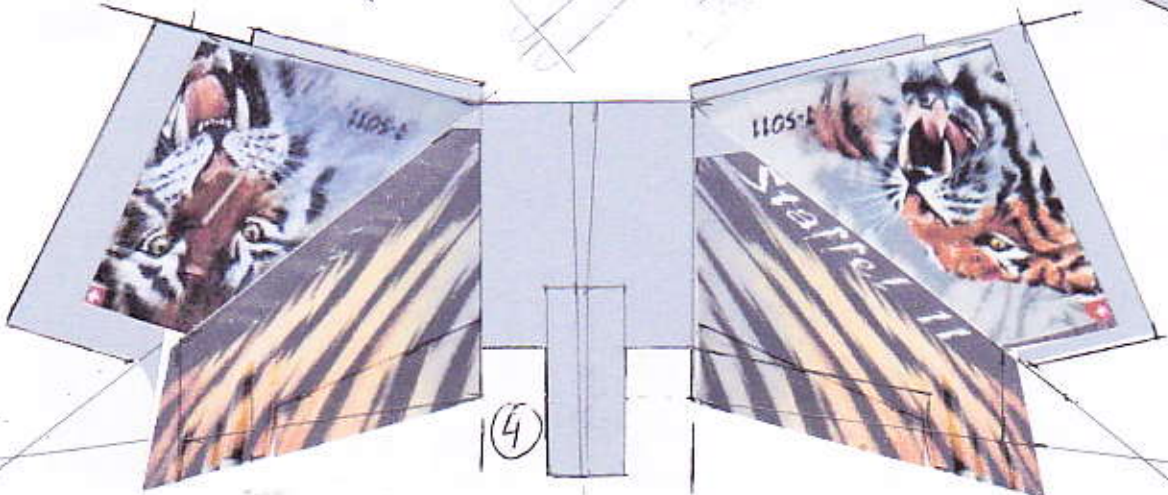
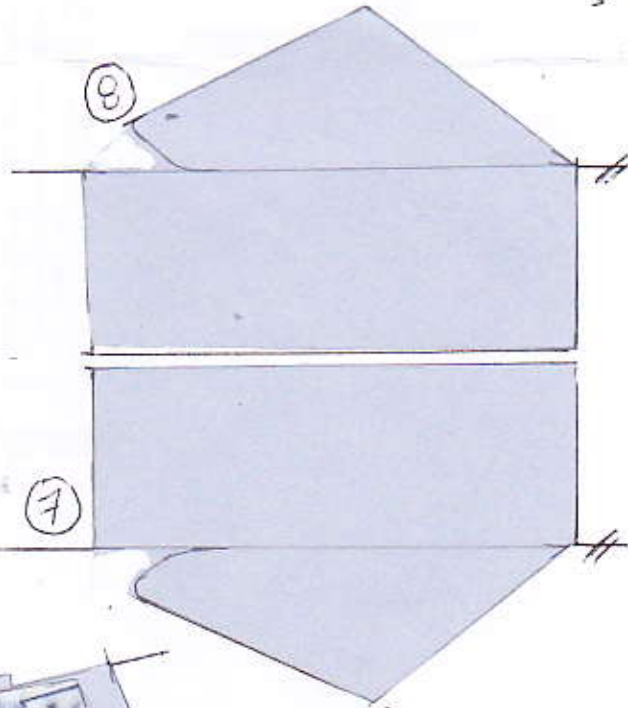
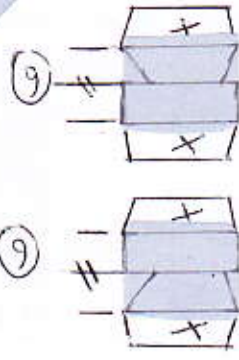
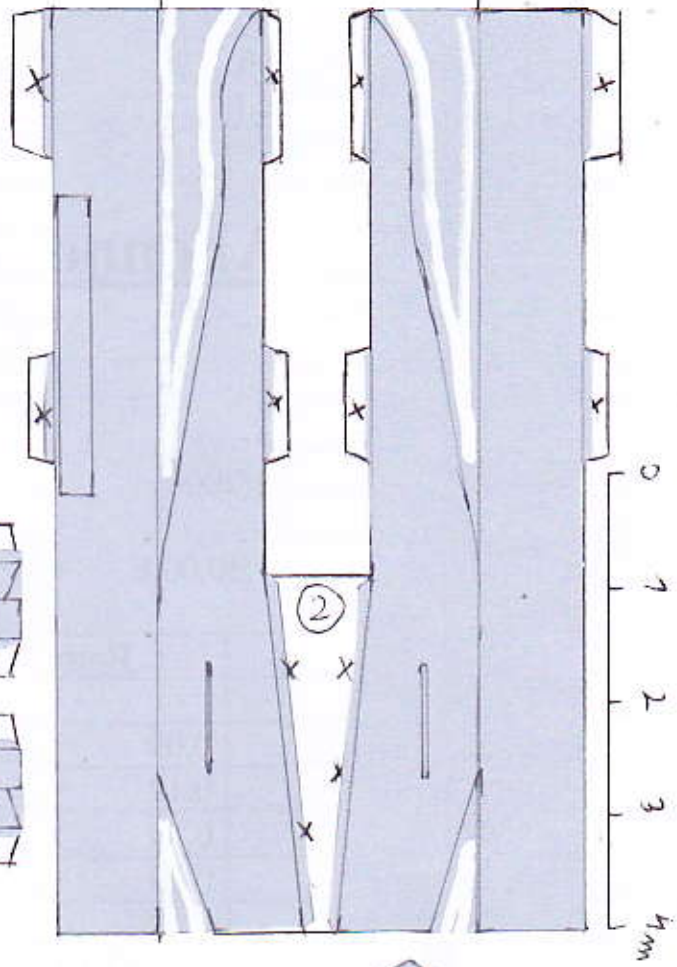
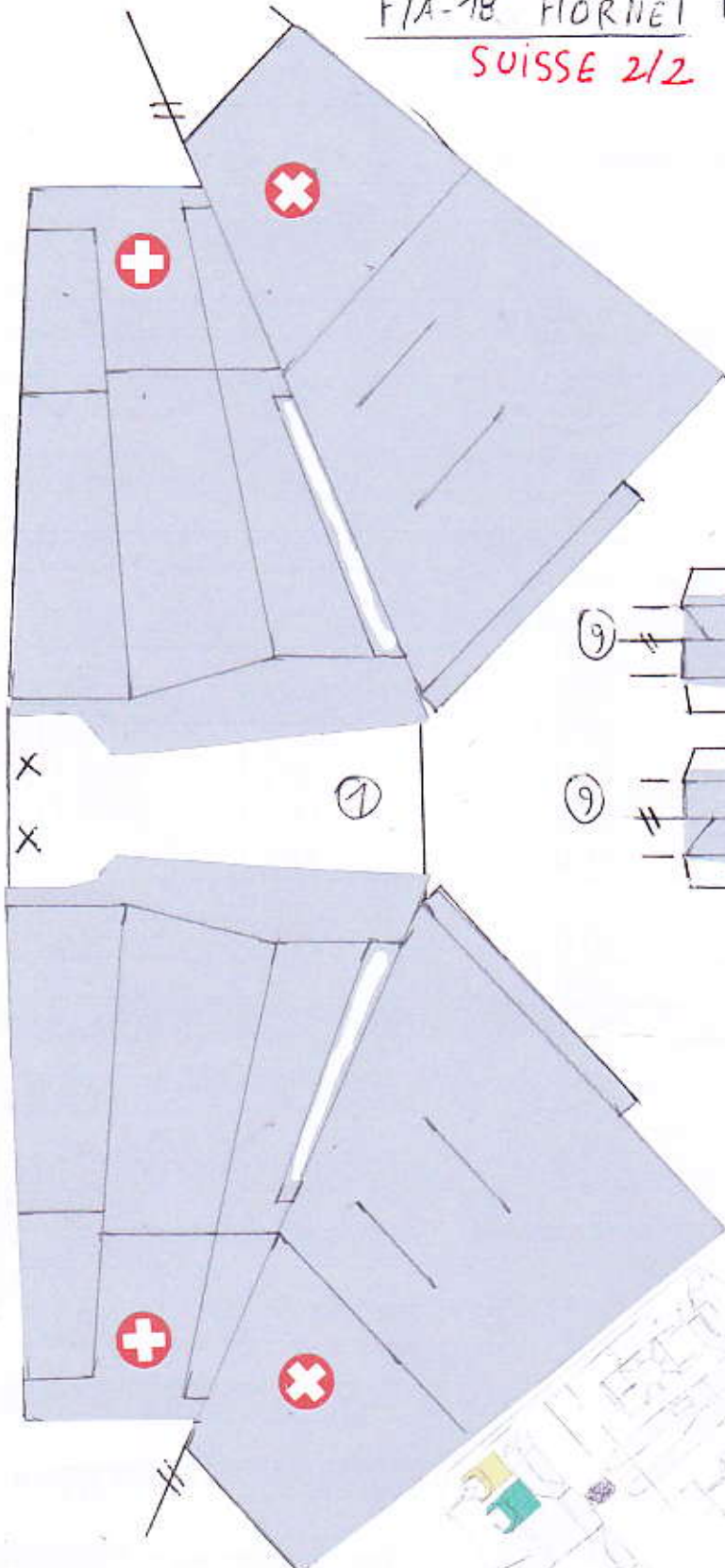

1/2

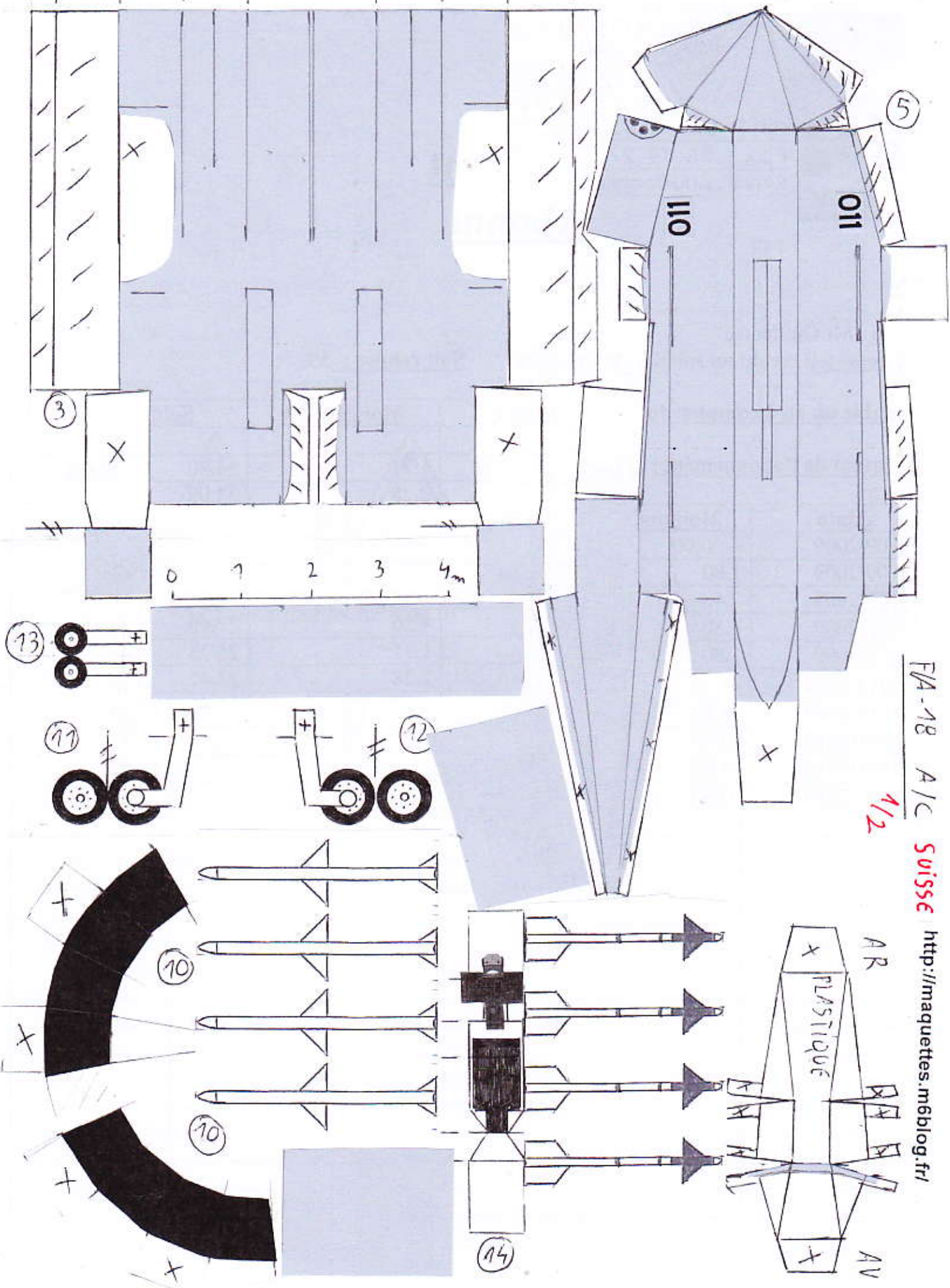

5

011

011

3

0 1 2 3 4m

13

17

12

10

10

14

AR

PLASTIQUE

AV

SUISSE 2/2

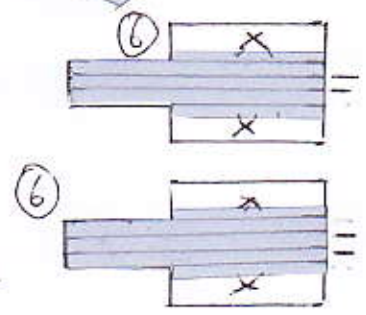
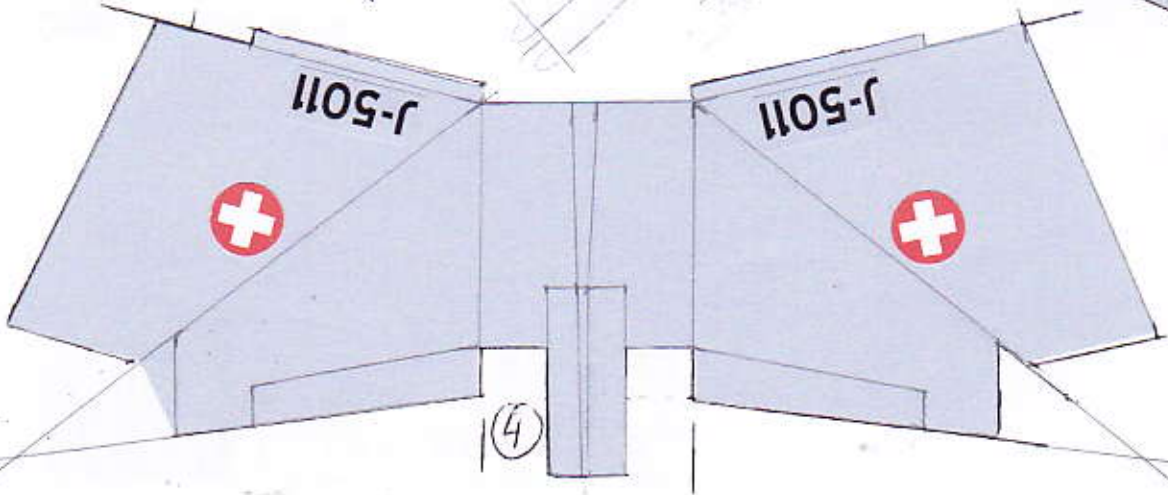
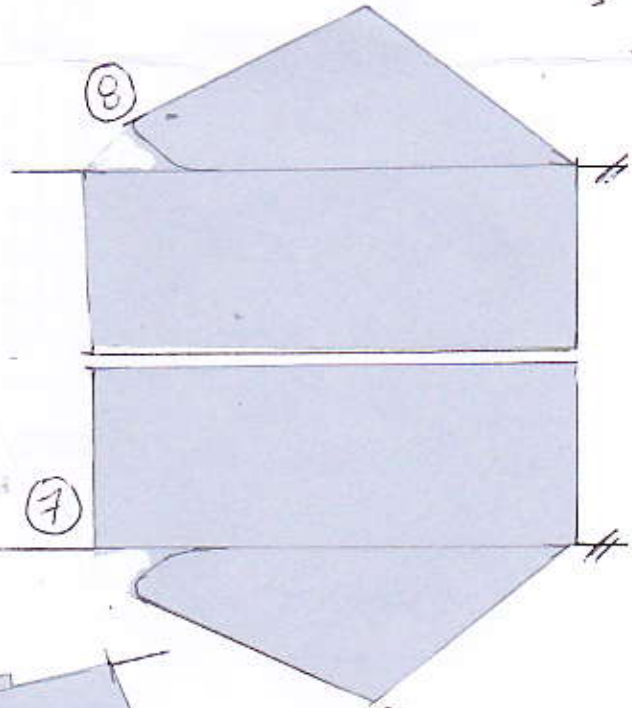
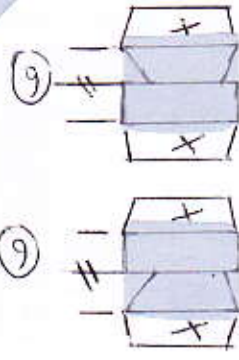
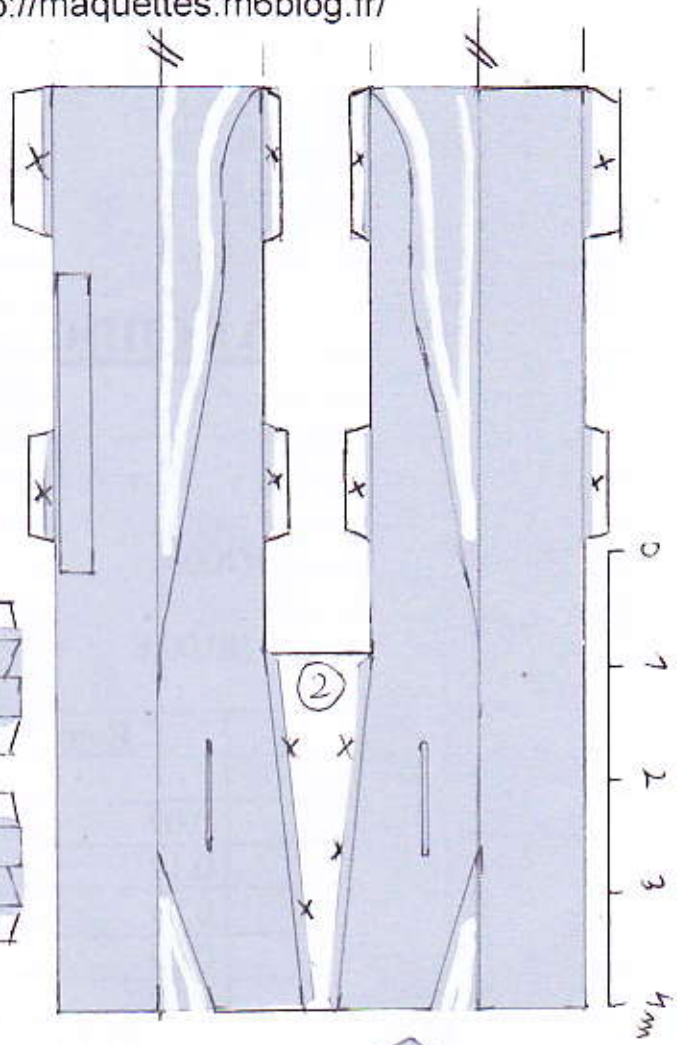
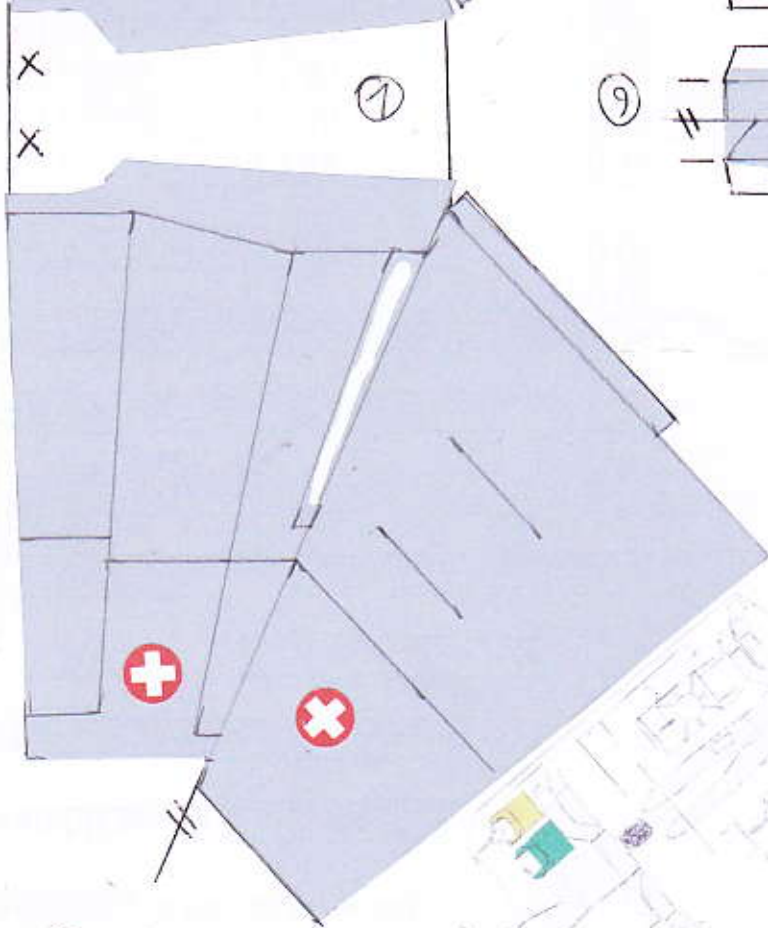
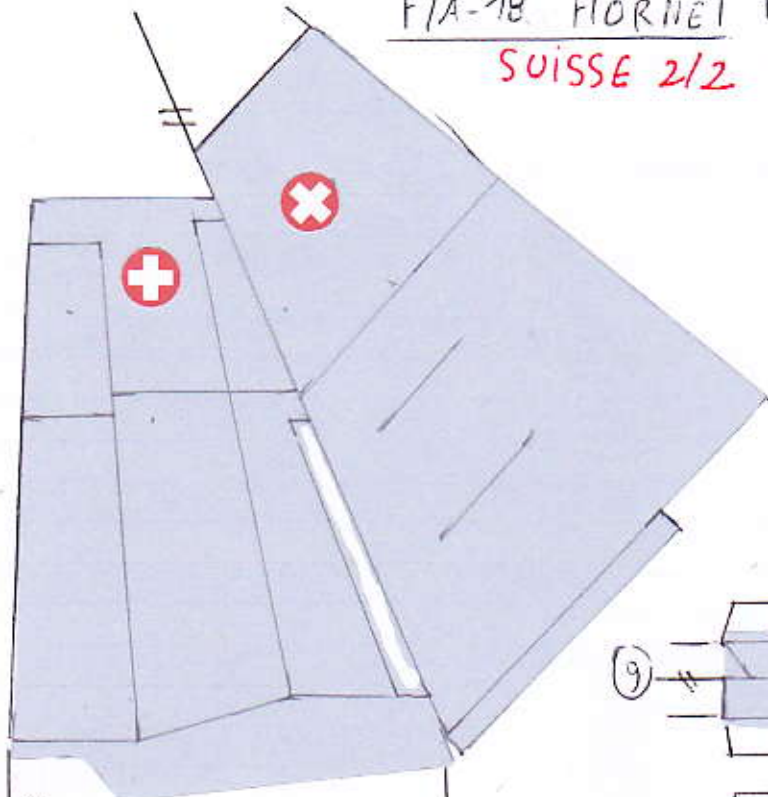



1/2

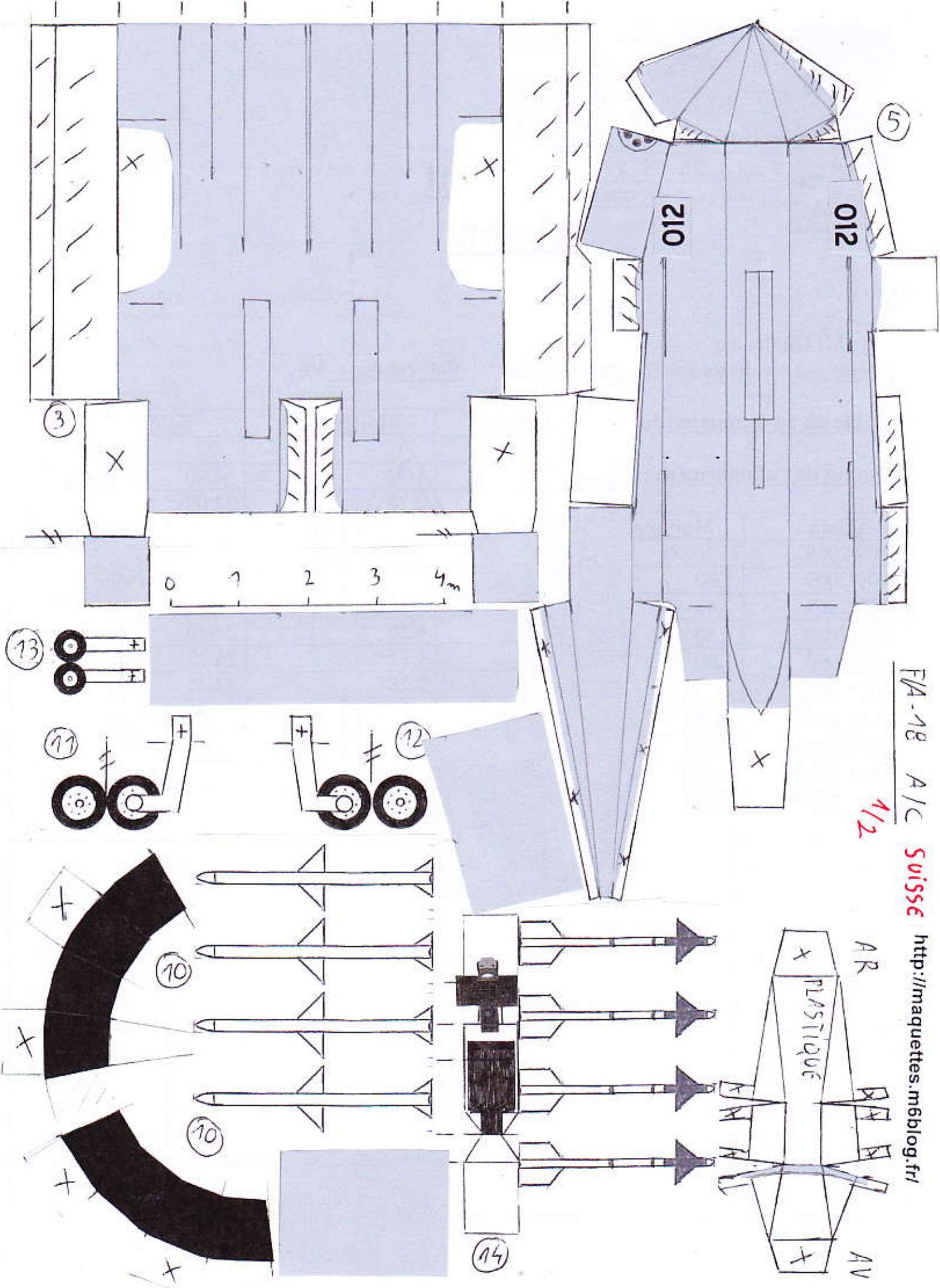

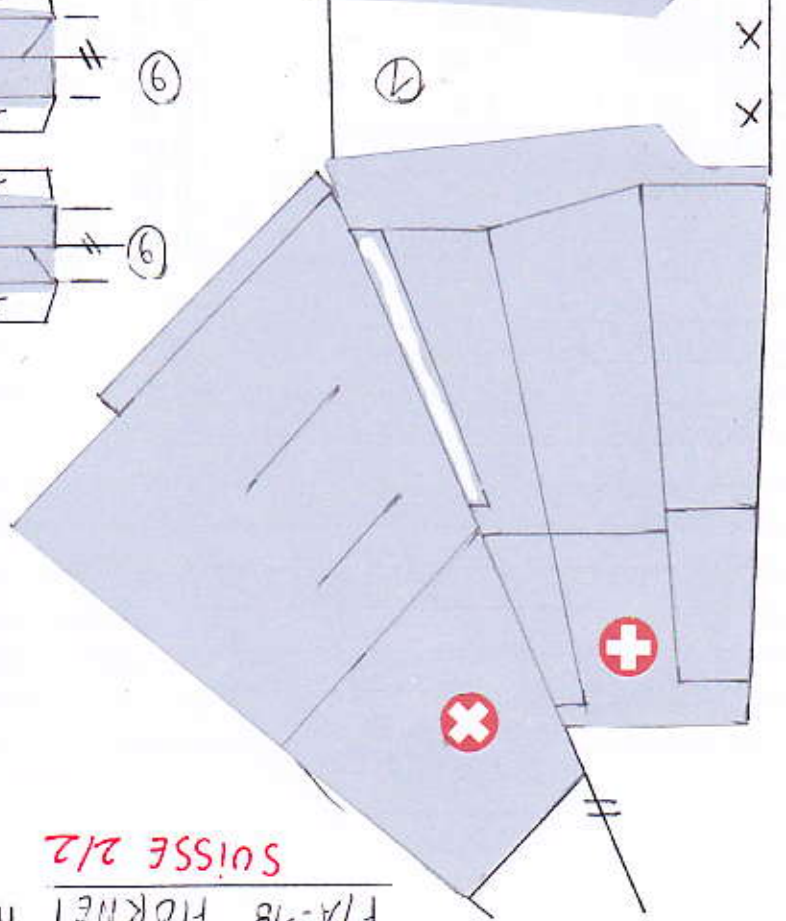
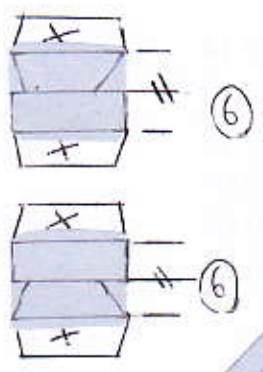
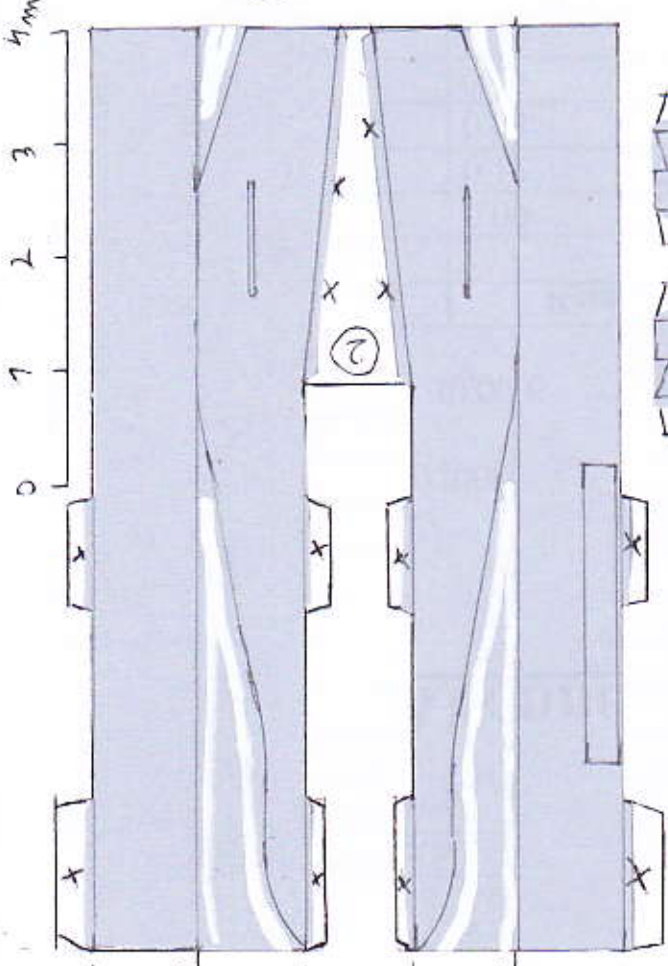
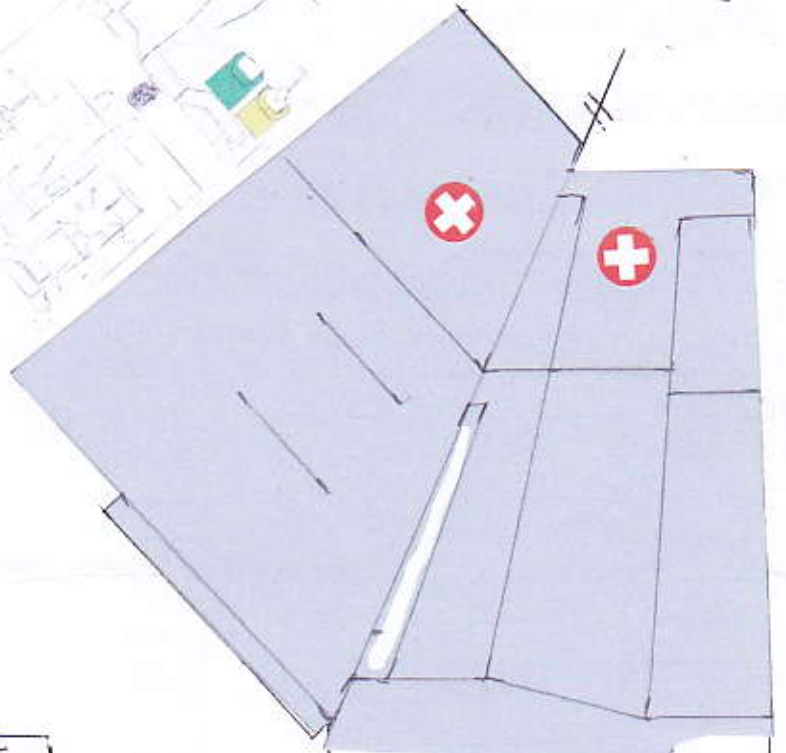
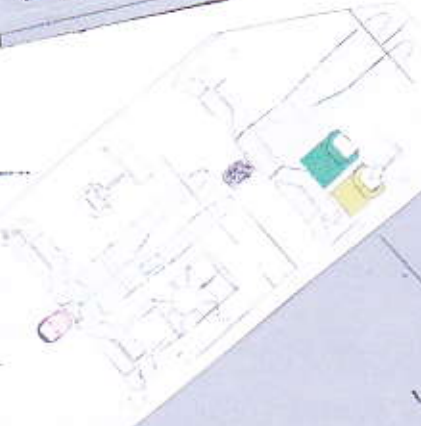
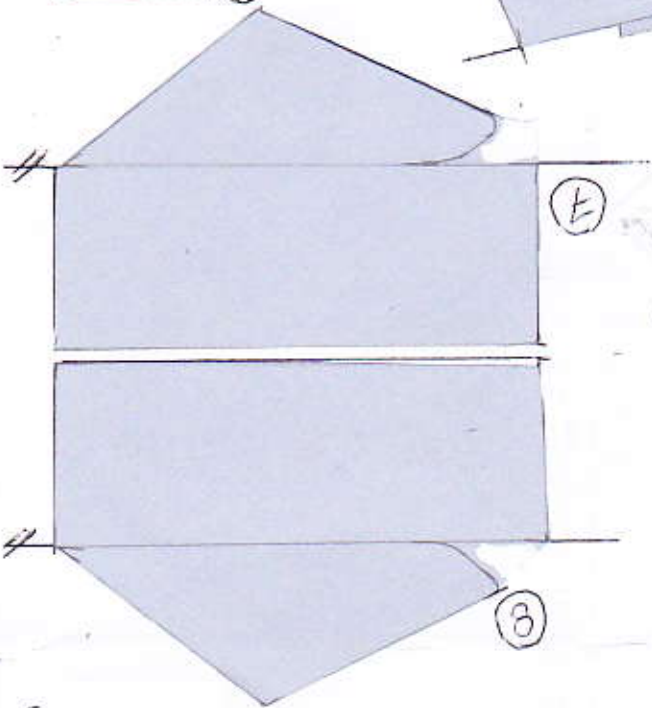
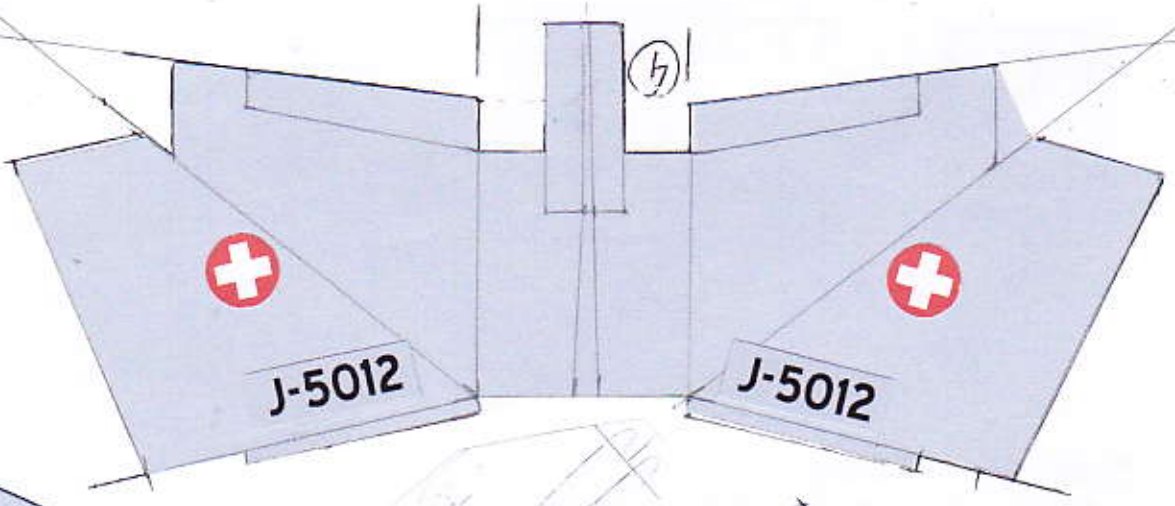
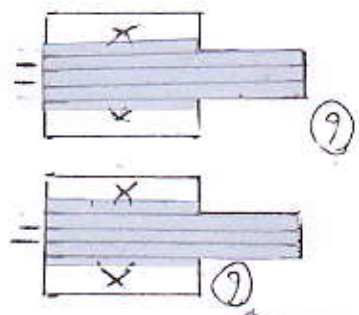

T1A-18 HORNEL  
 ntp://maquettes.morig.it/ SWISSE 212



1/2

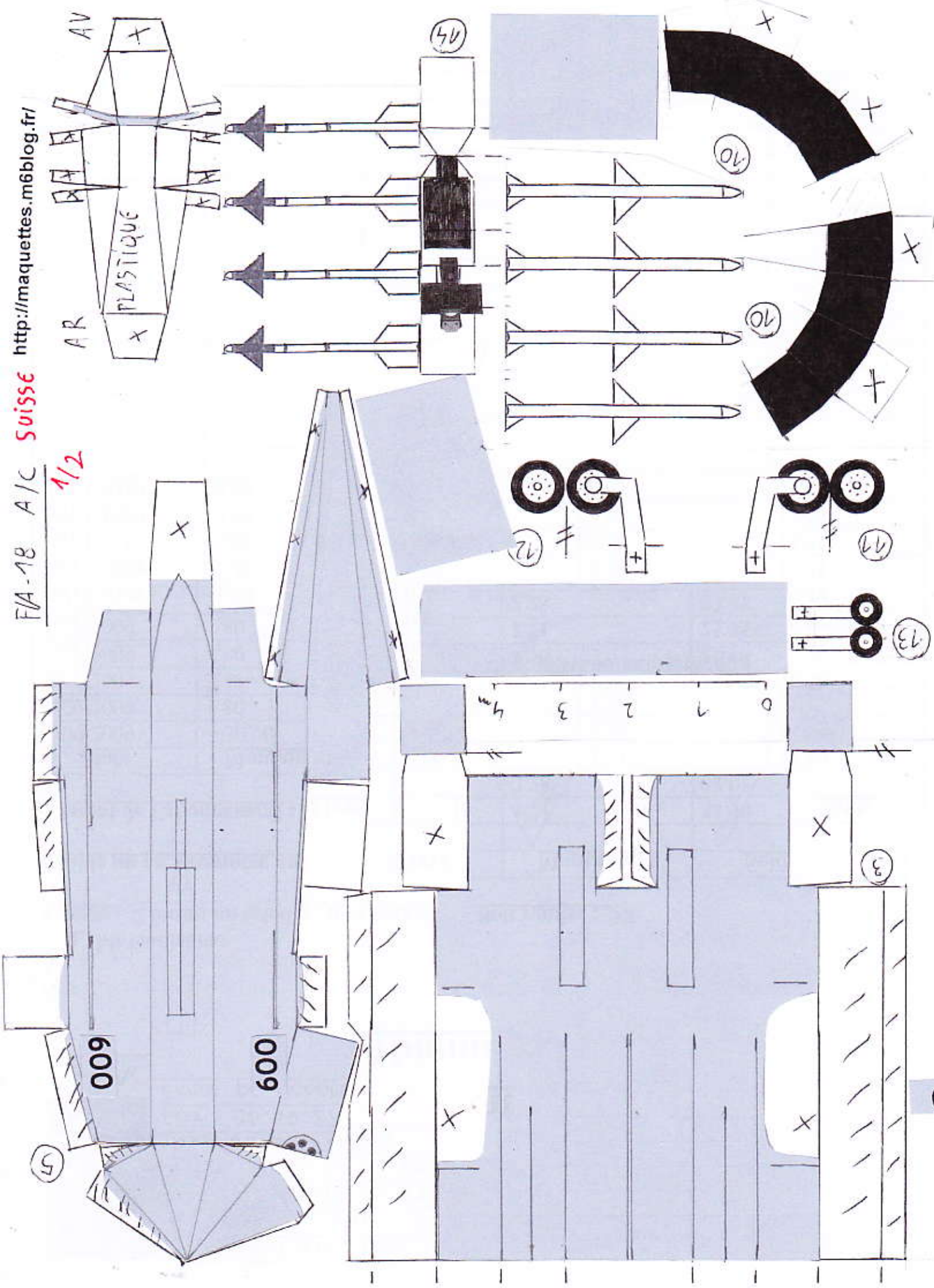

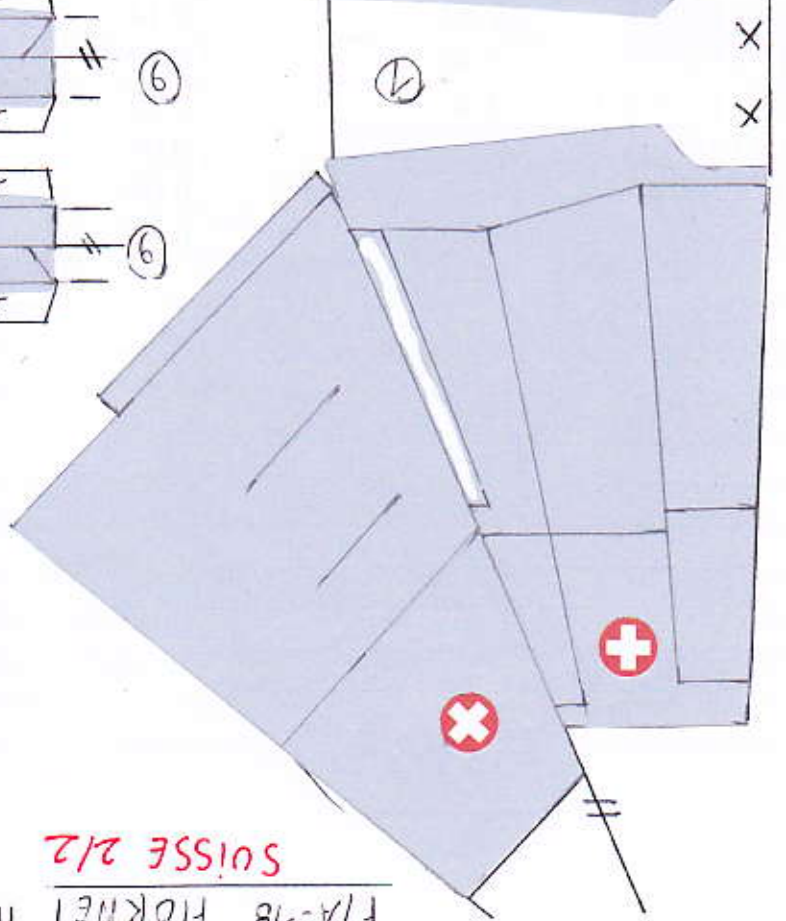
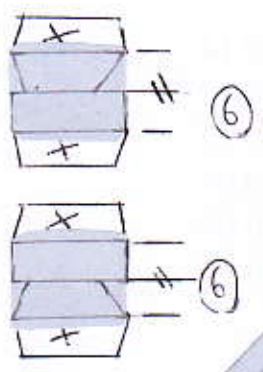
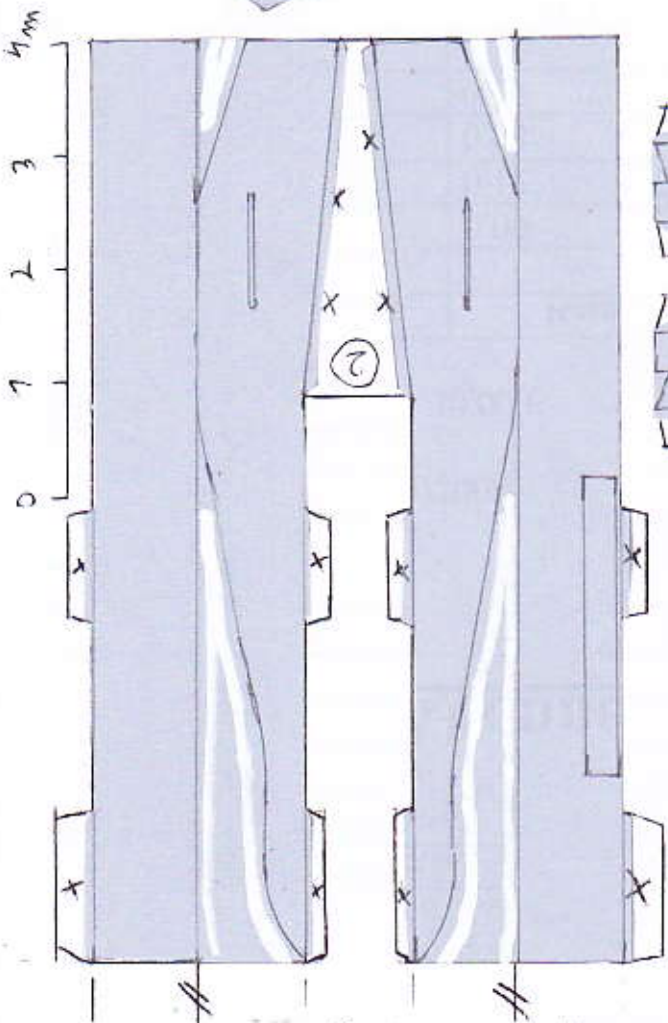
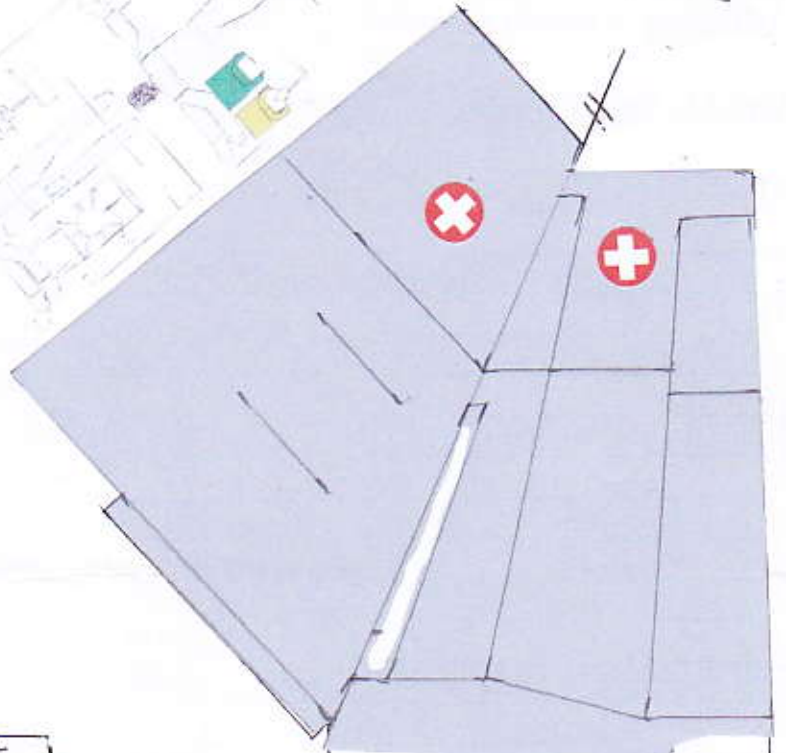
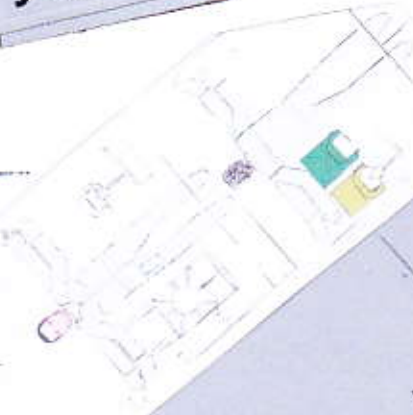
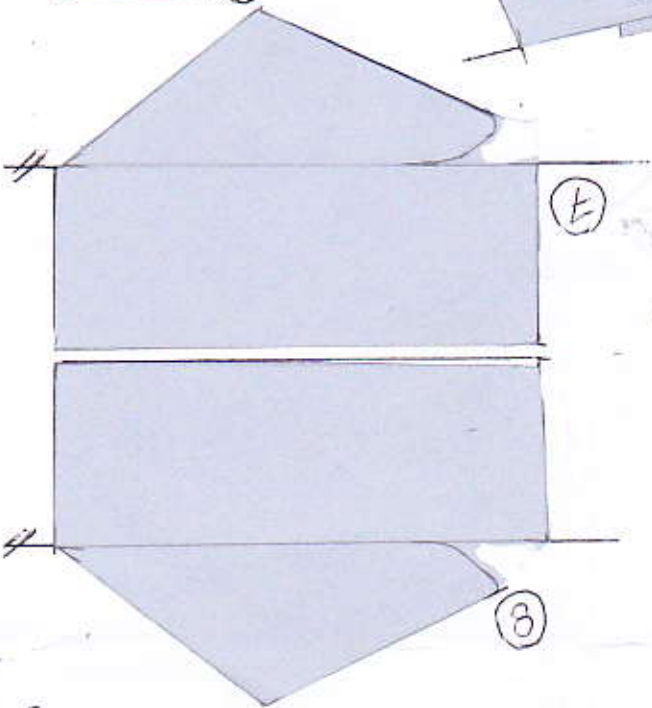
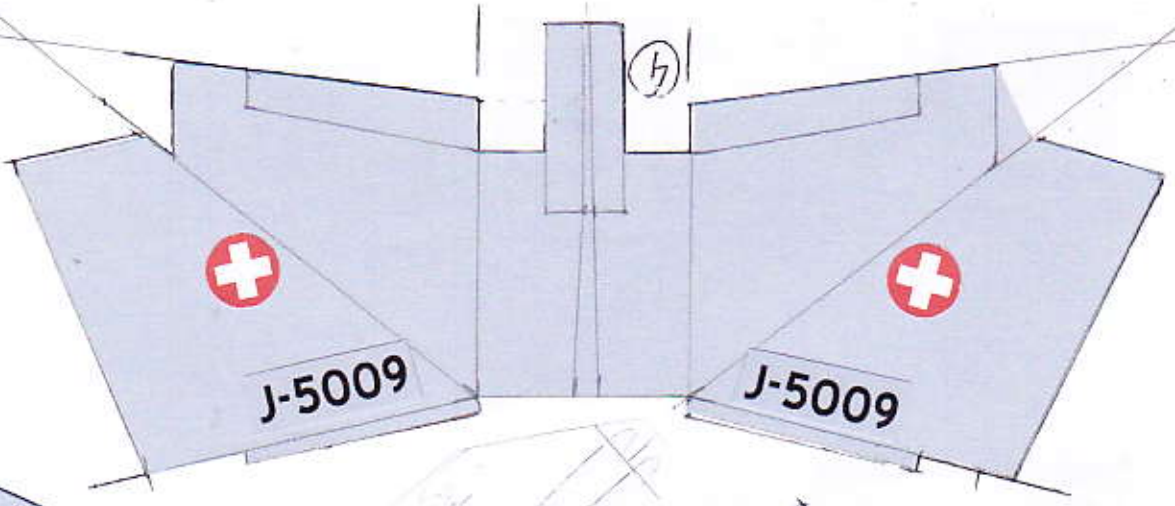
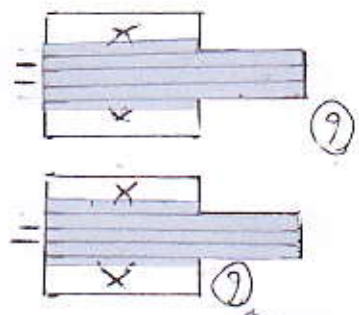

T1A-18 HORNEL  
 http://maquettes.morig.it/

SUISSE 212