

114

<http://maquettes.m6blog.fr/>

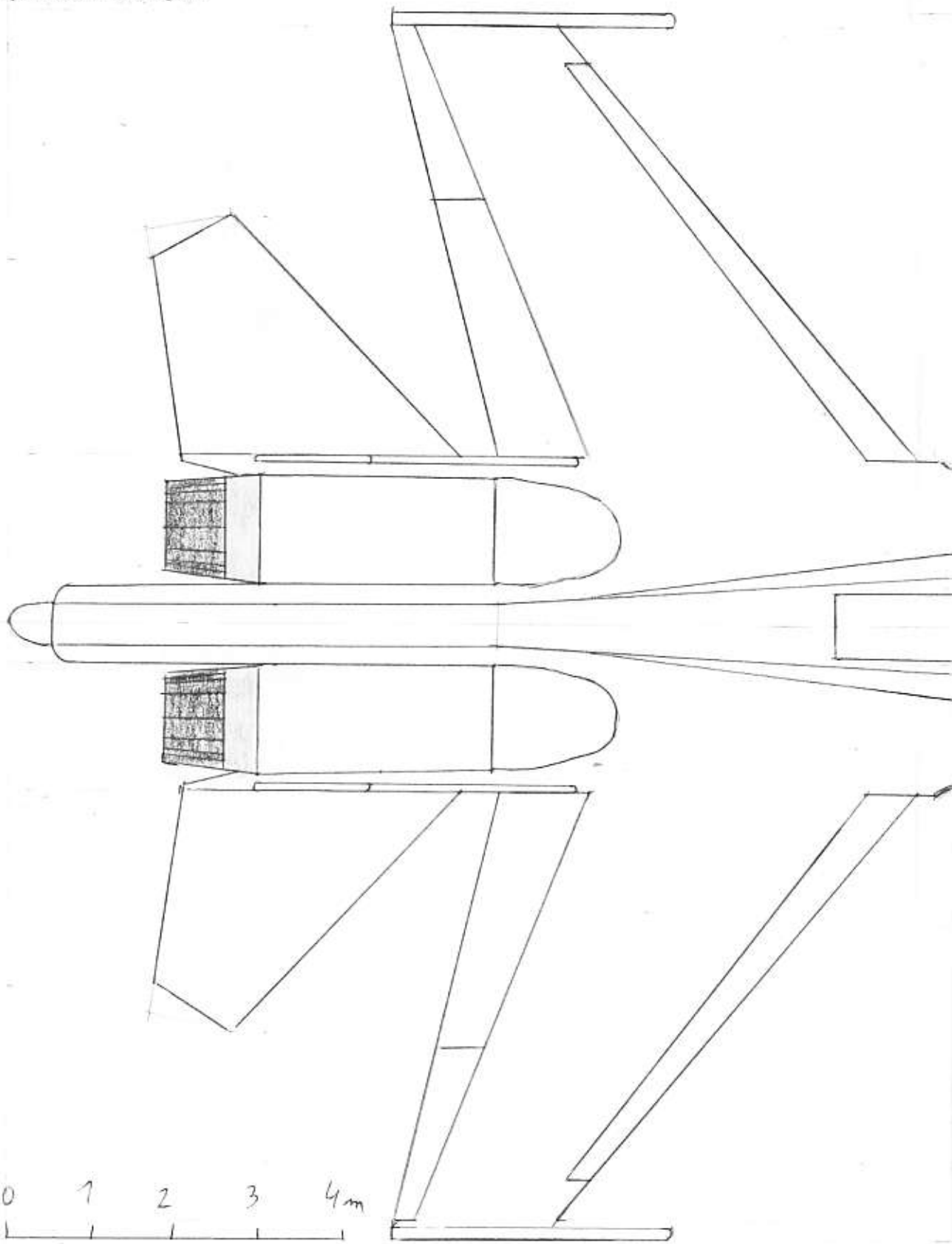

0 1 2 3 4m

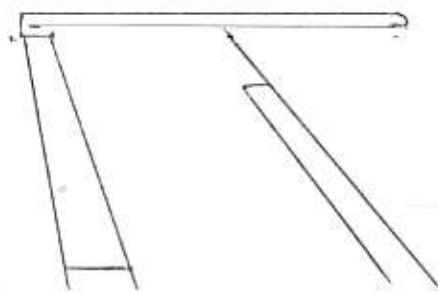

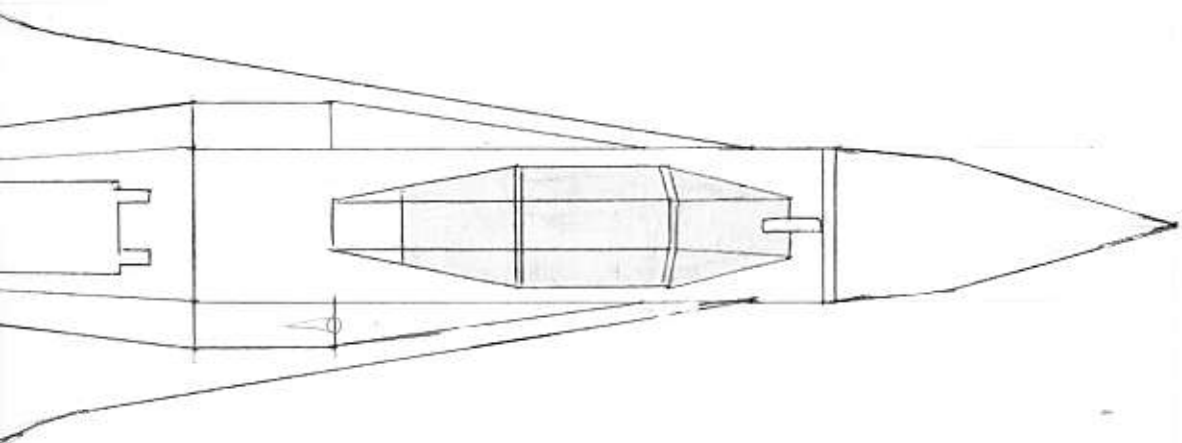

<http://maquettes.m6blog.fr/>

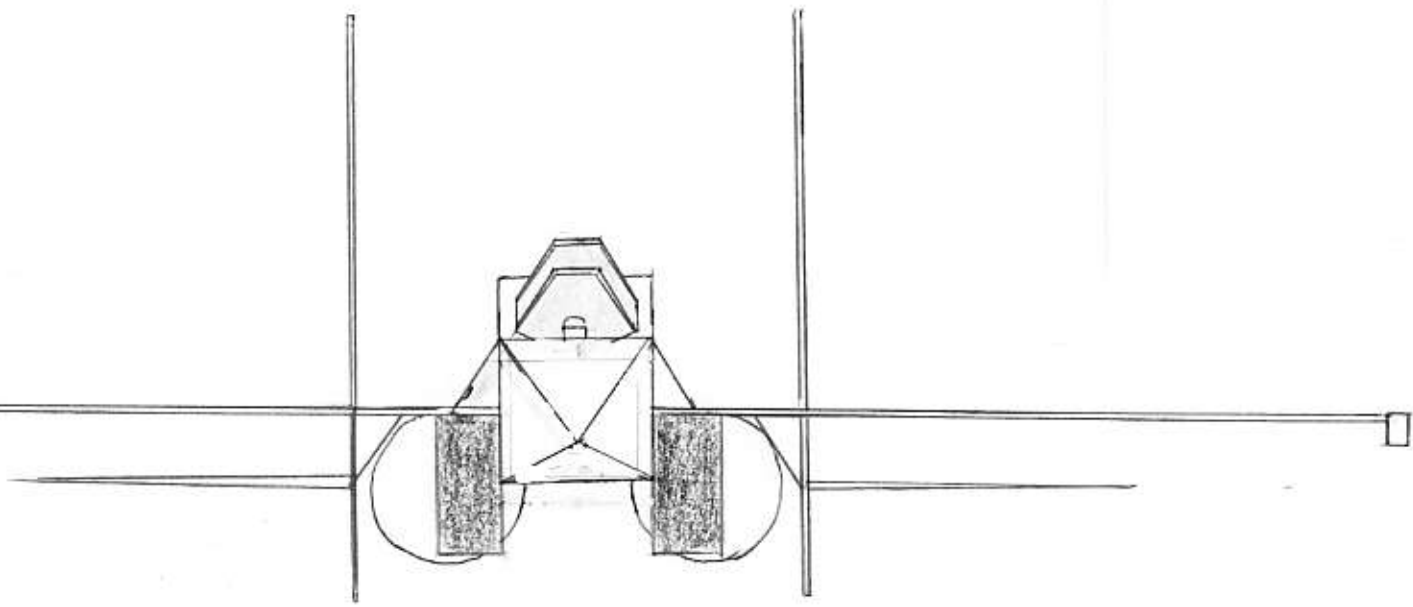

3/4

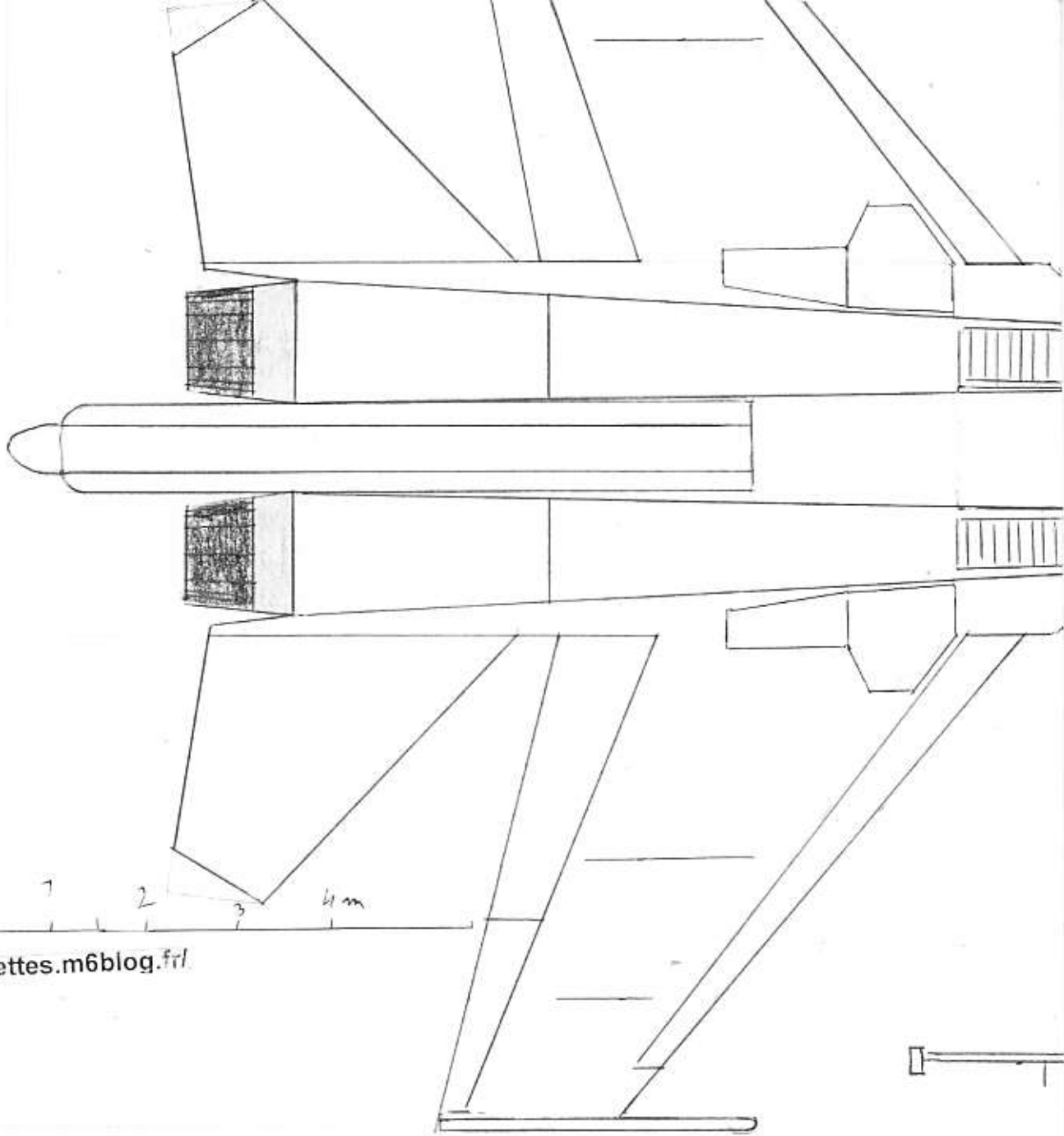

<http://maquettes.m6blog.fr/>

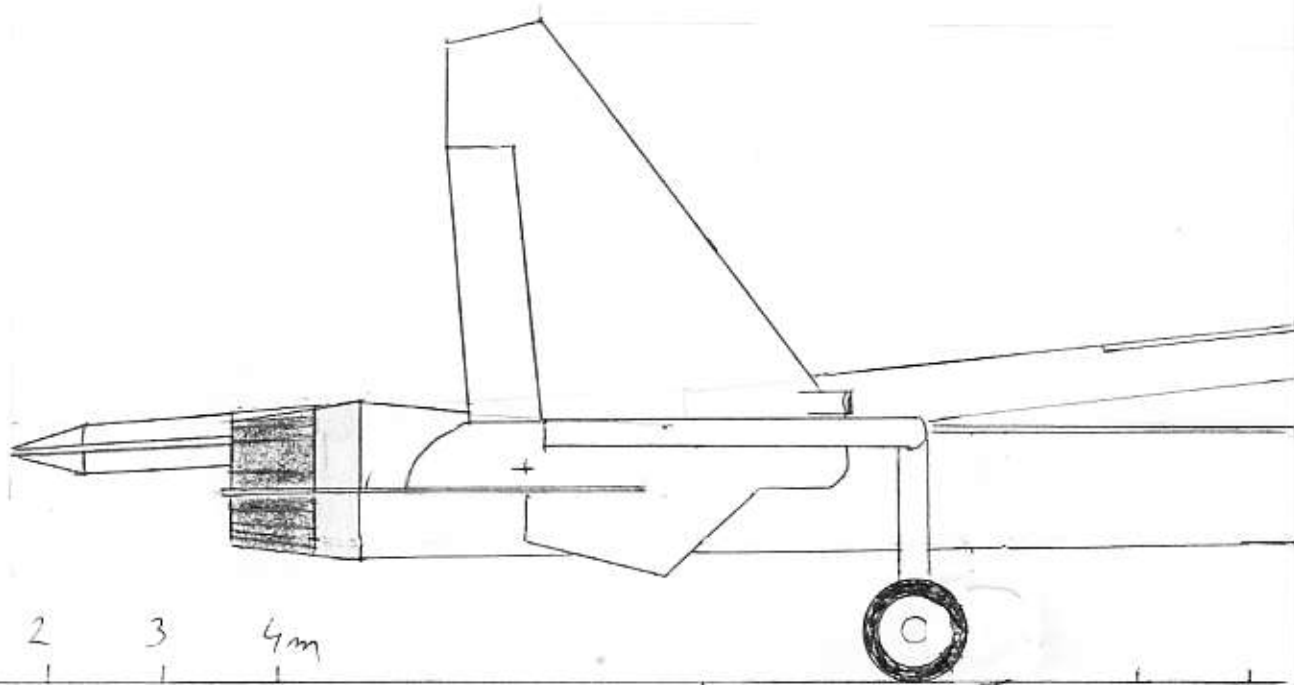

0 1 2 3 4m

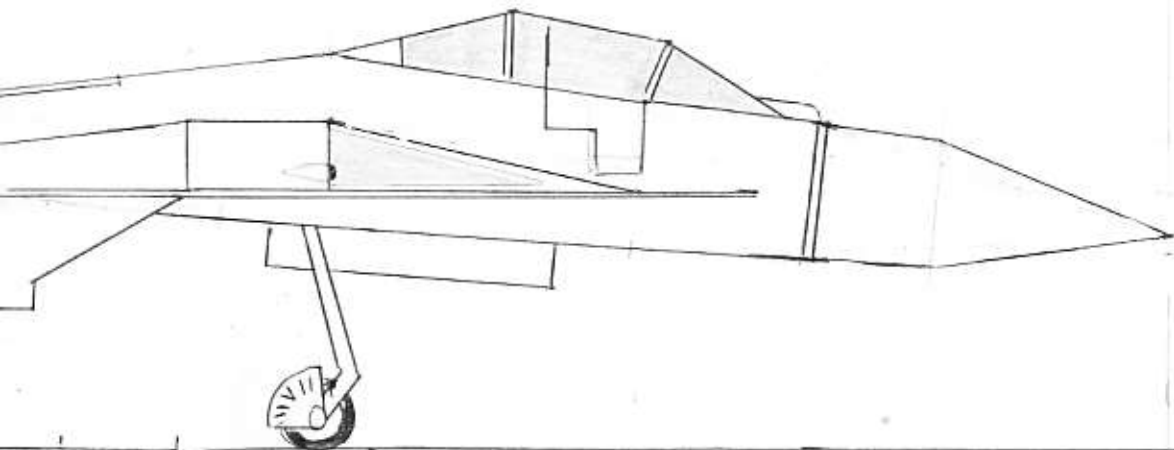
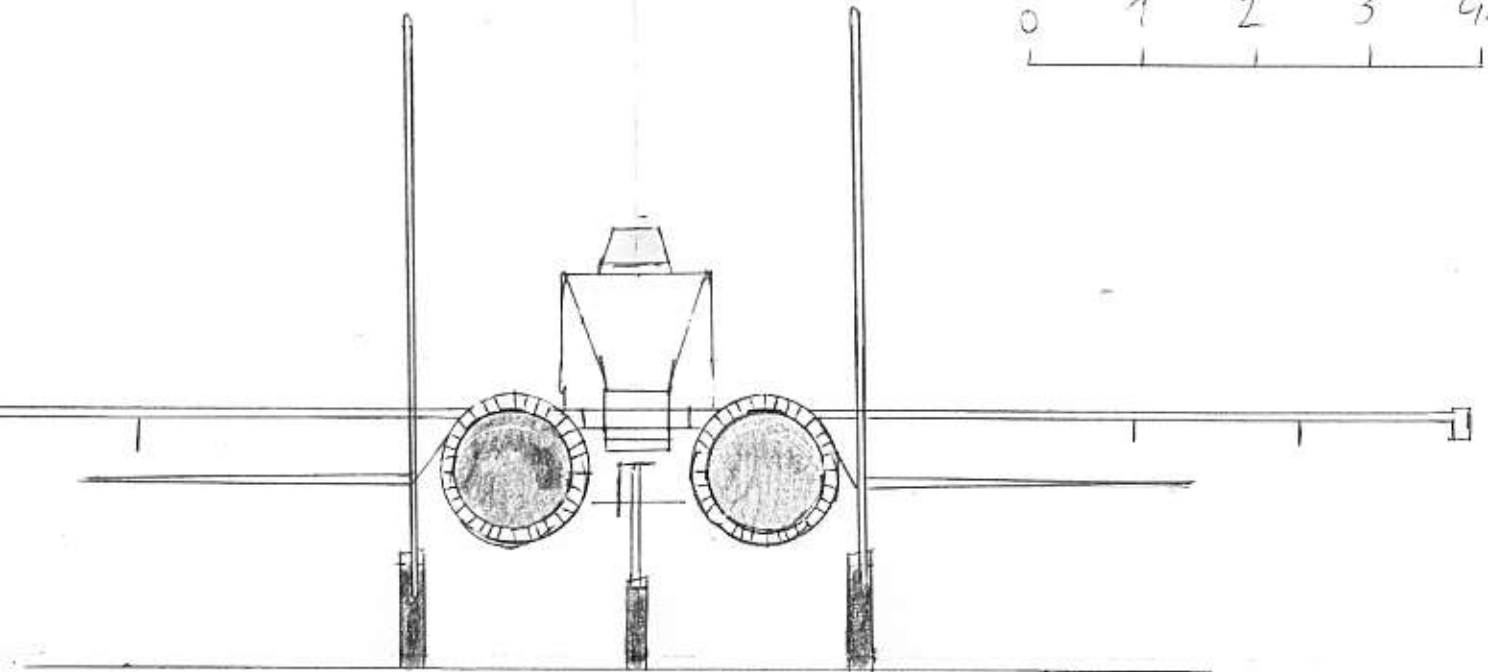
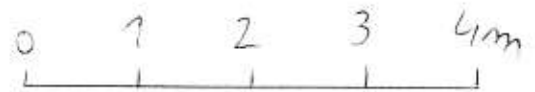
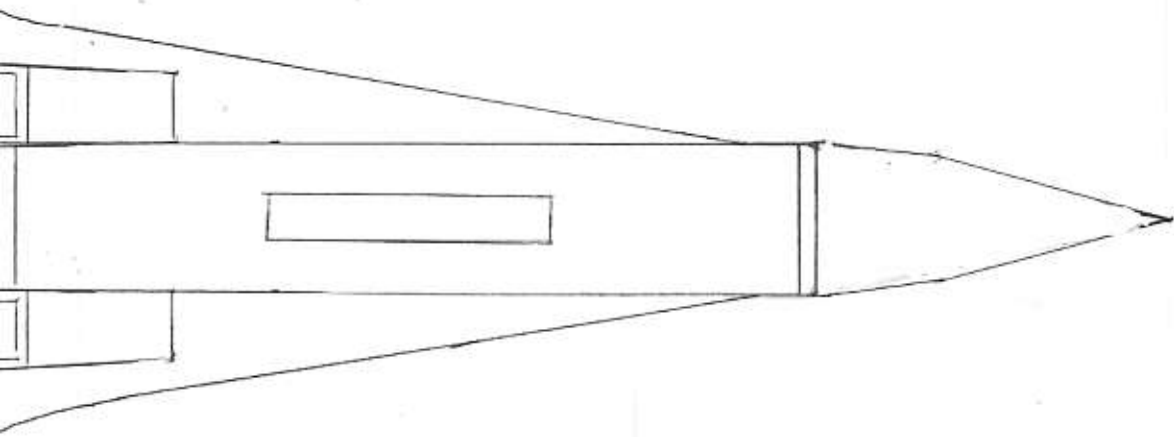
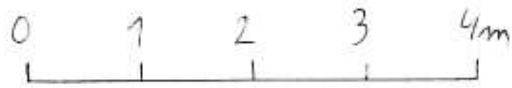

0 1 2 3 4m

<http://maquettes.m6blog.fr/>

7/4

23

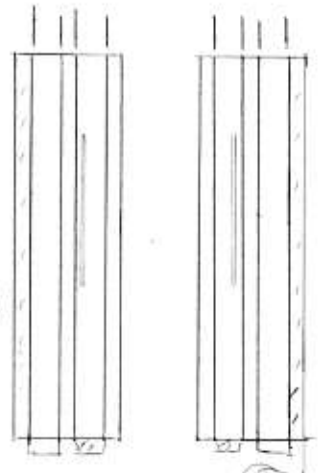

23

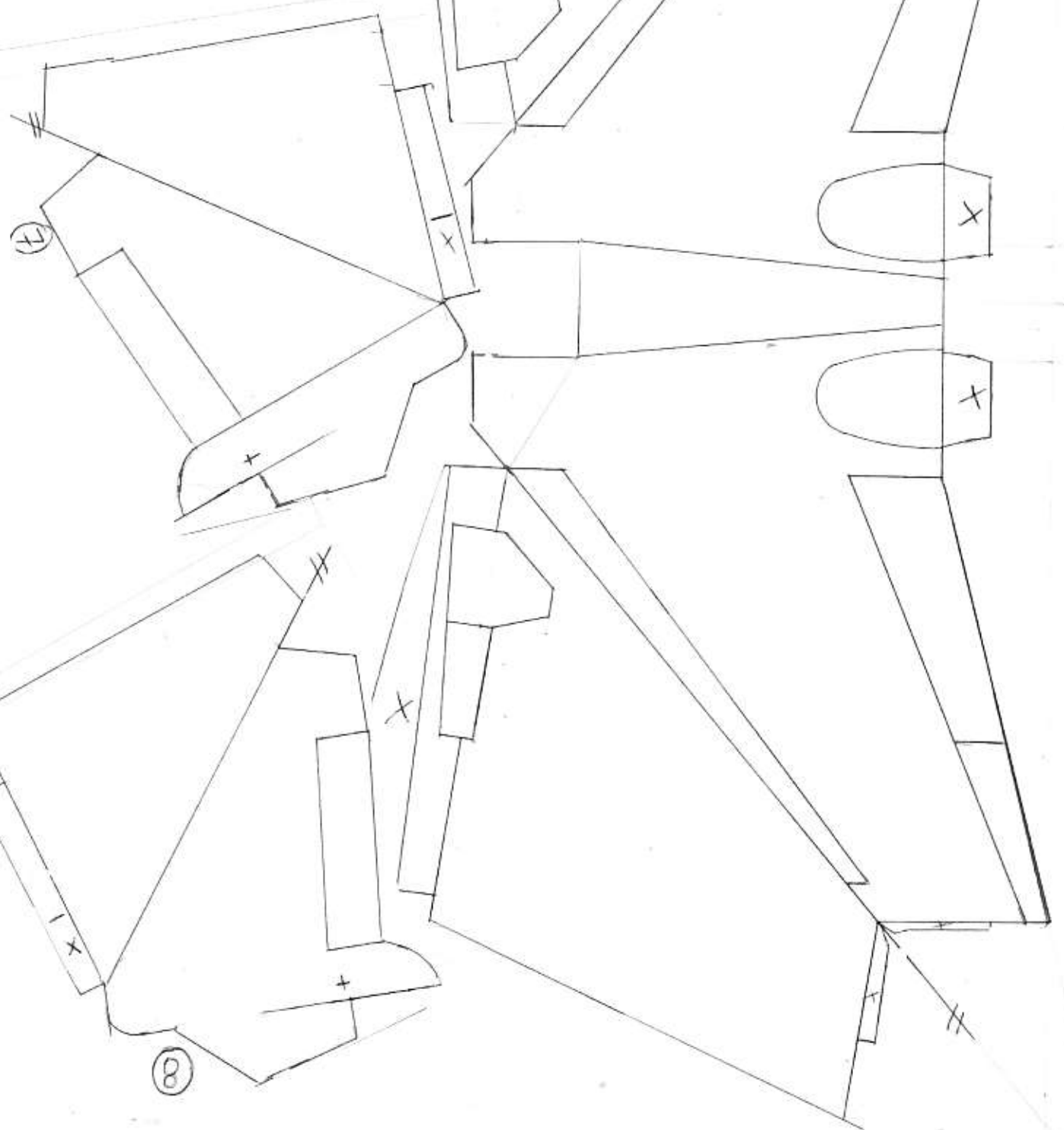

7

8

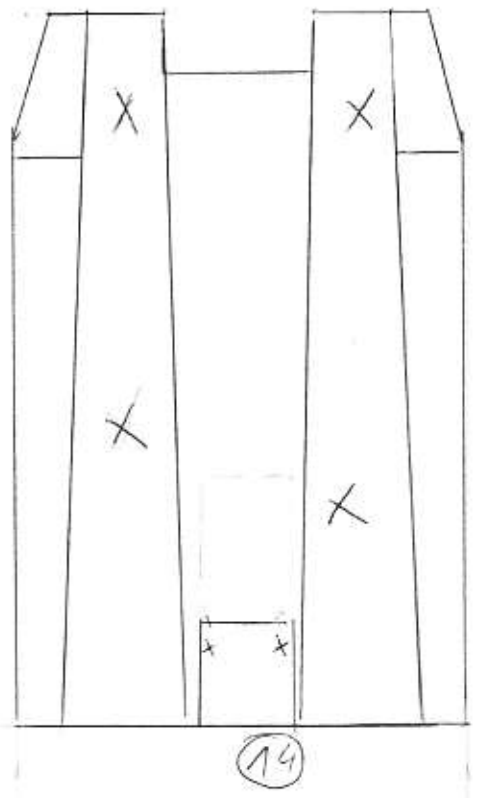
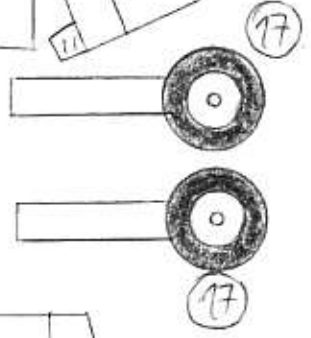
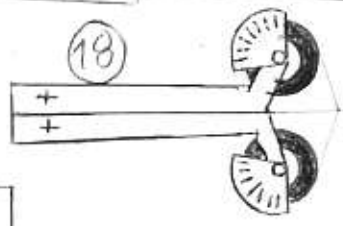
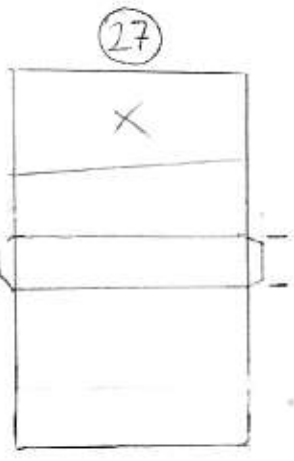
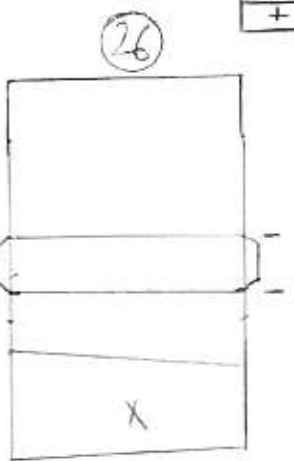
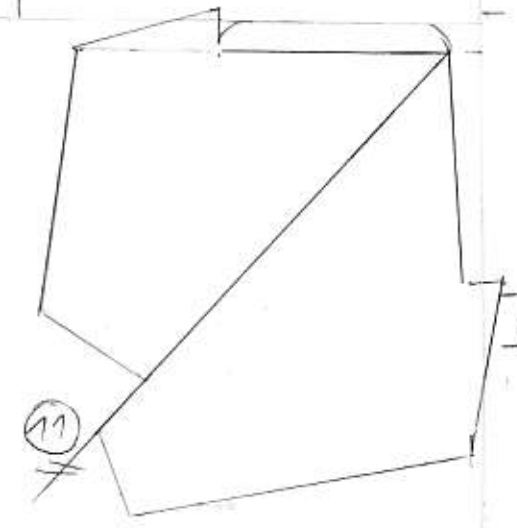
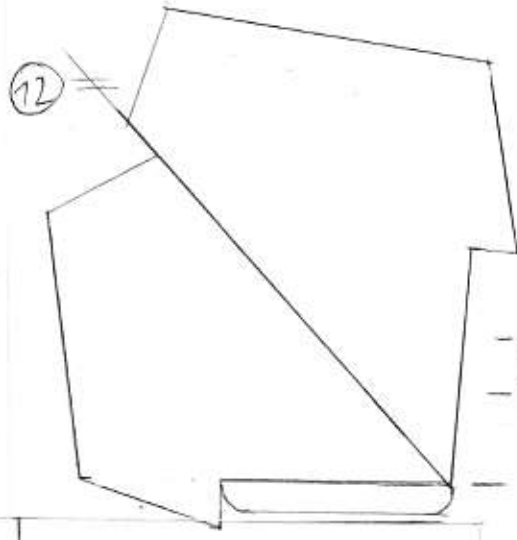
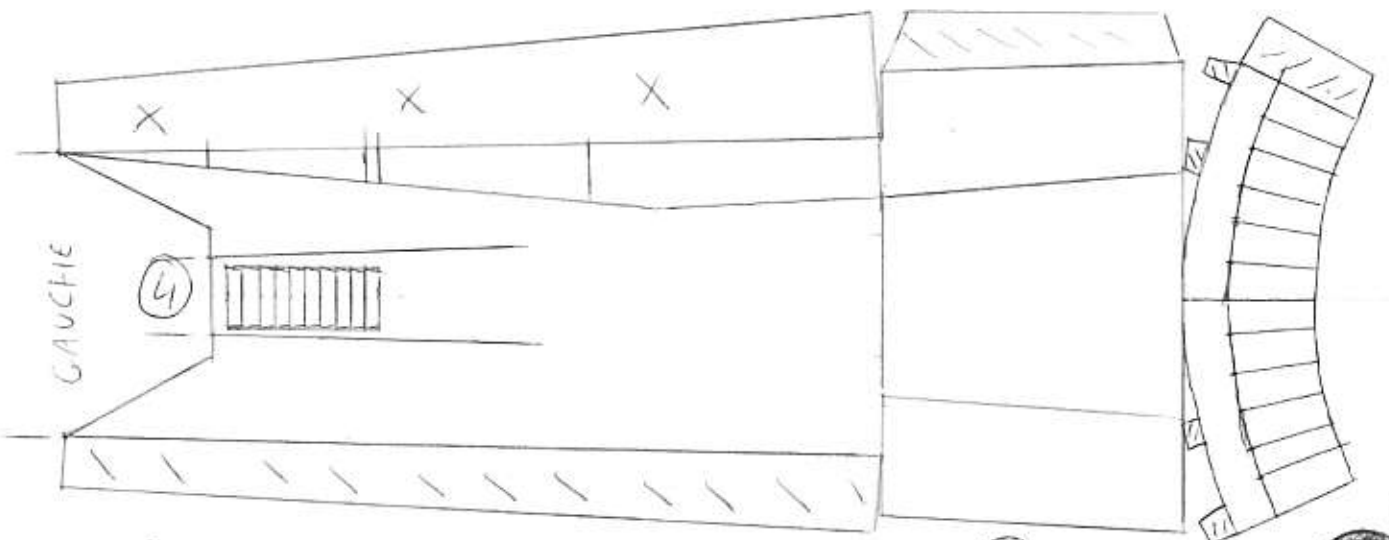
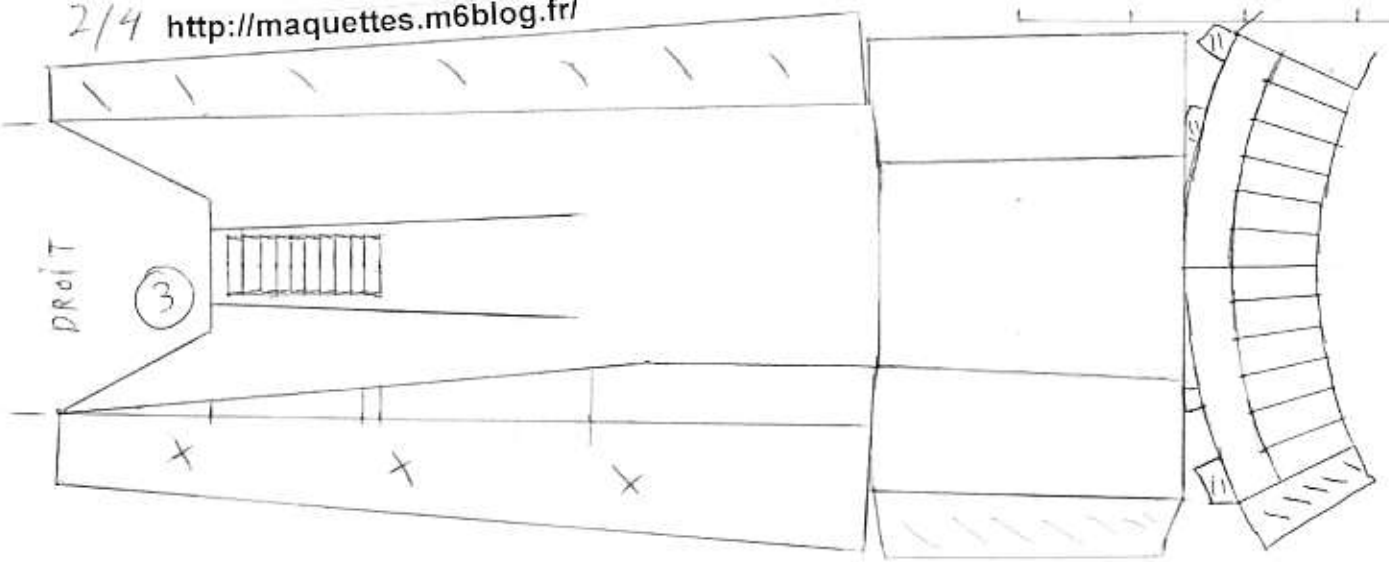

3/4

0 1 2 3 4 cm

<http://maquettes.m6blog.fr/>

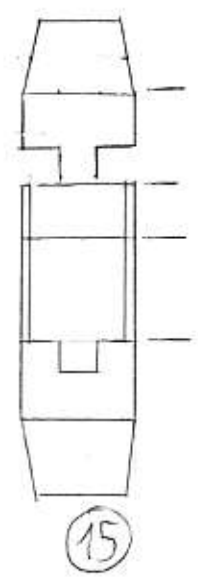
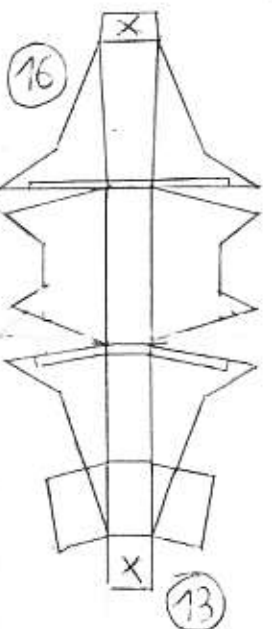
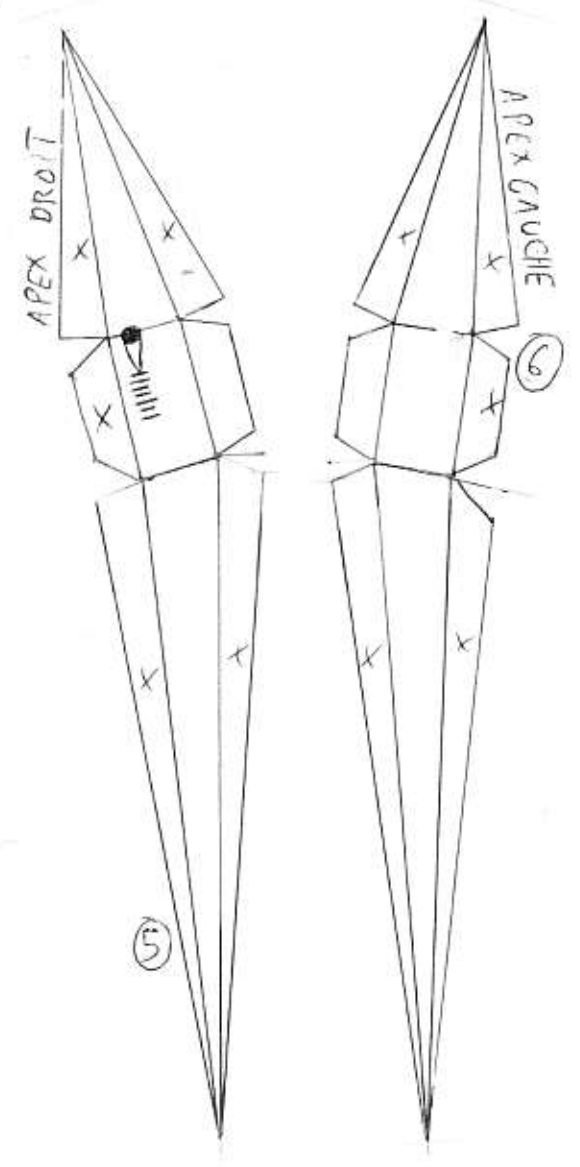
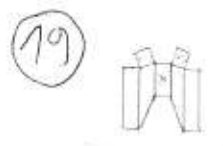
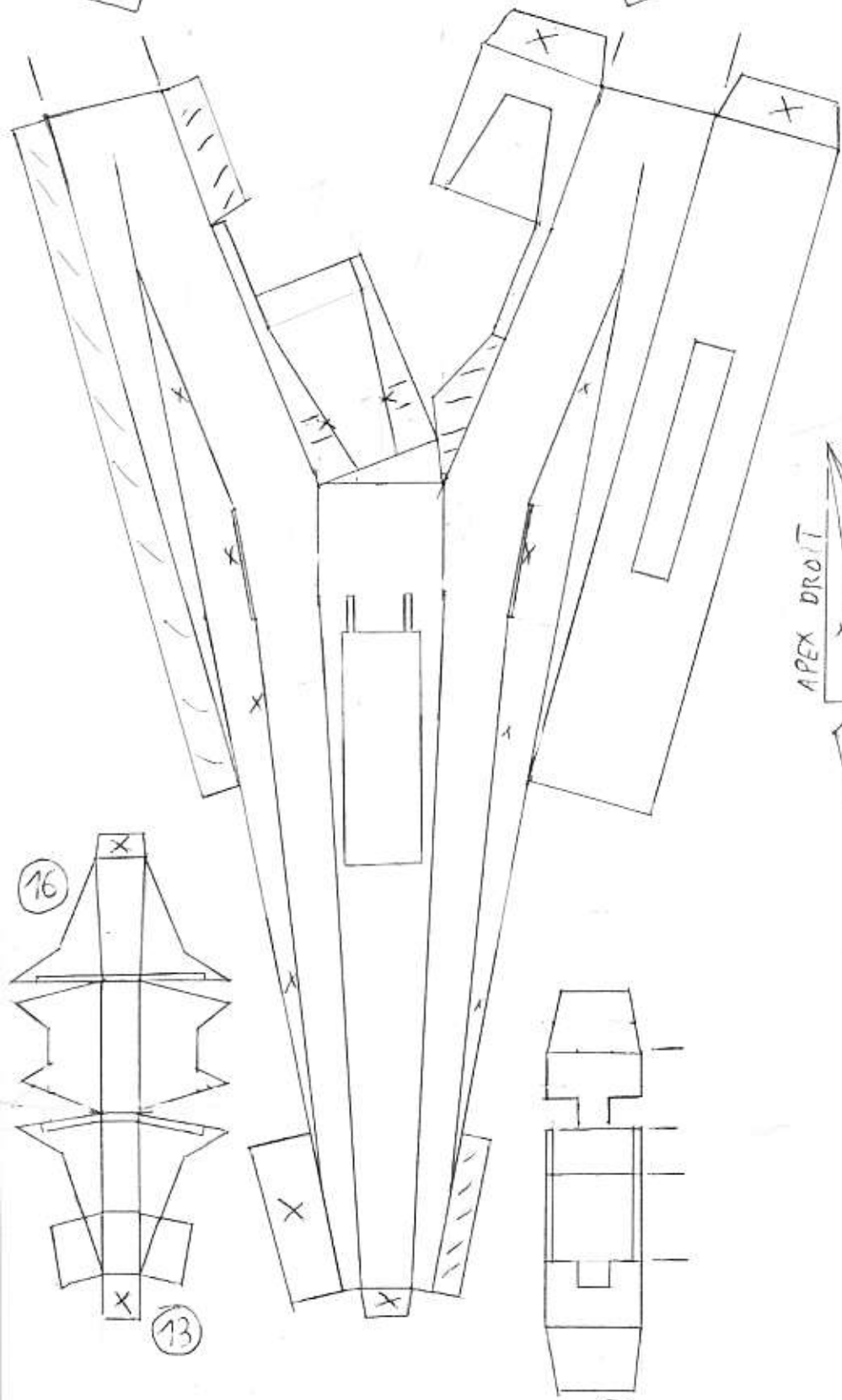
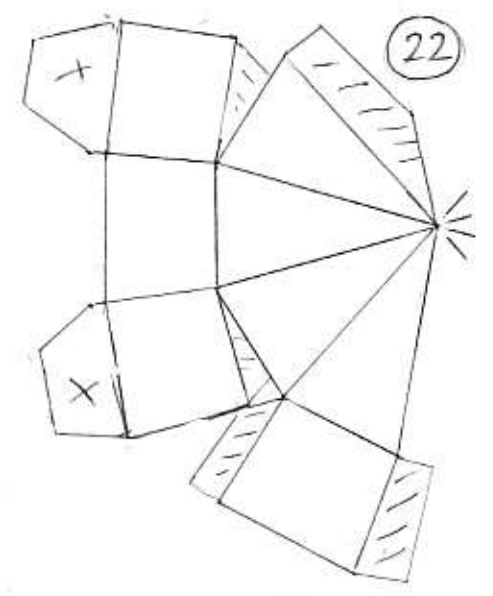
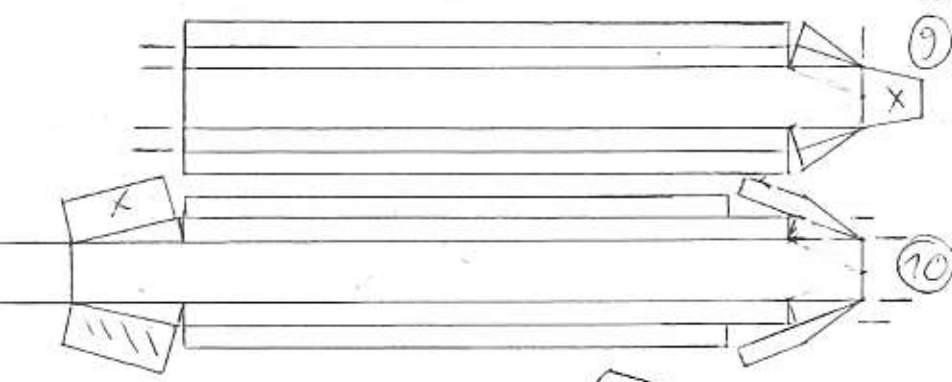

RENFORTS 2/2

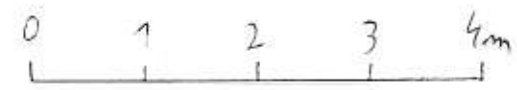
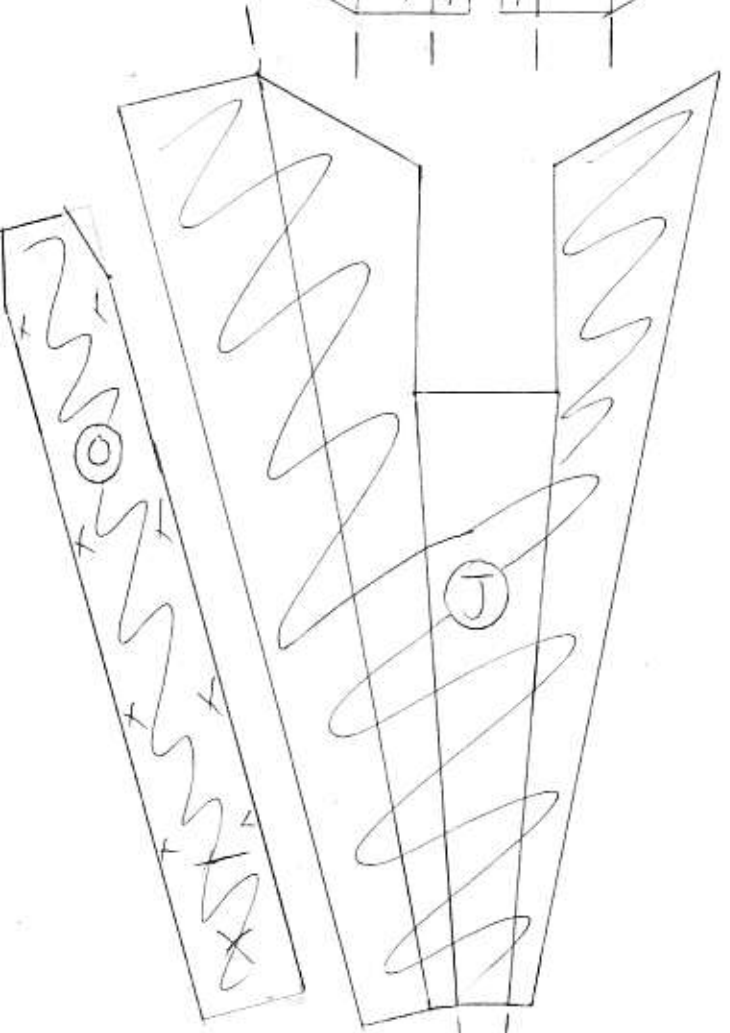
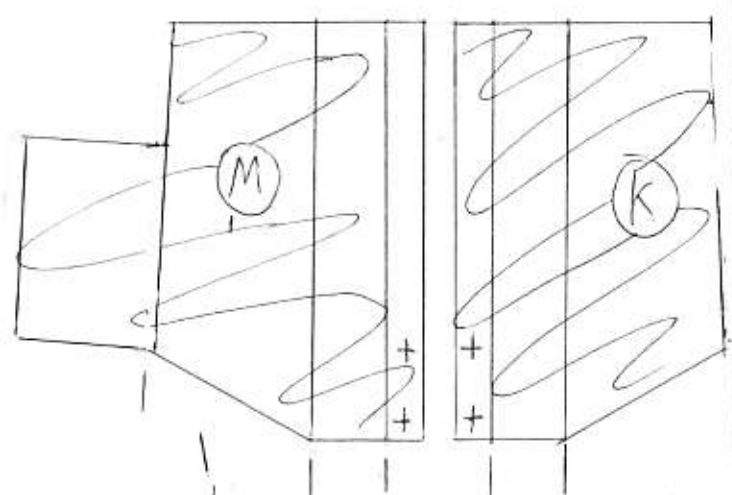
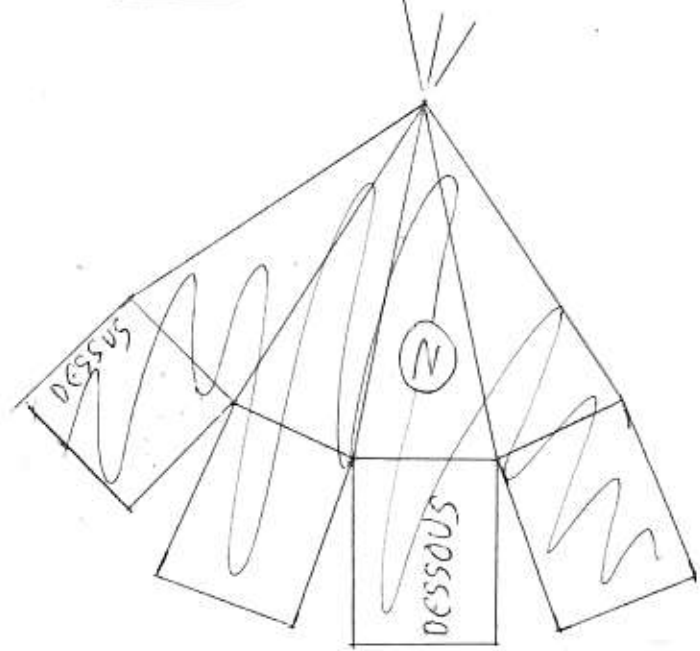

<http://maquettes.m6blog.fr/>

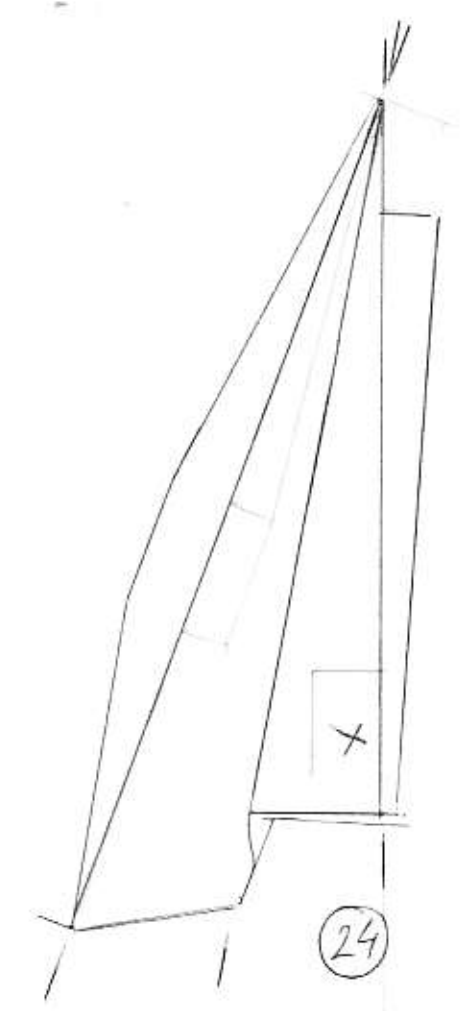
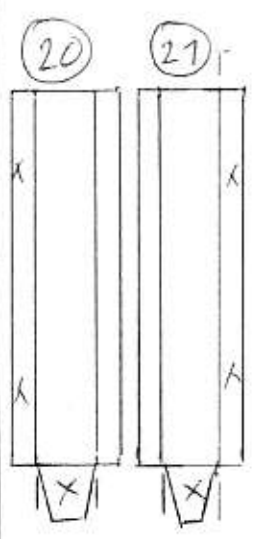
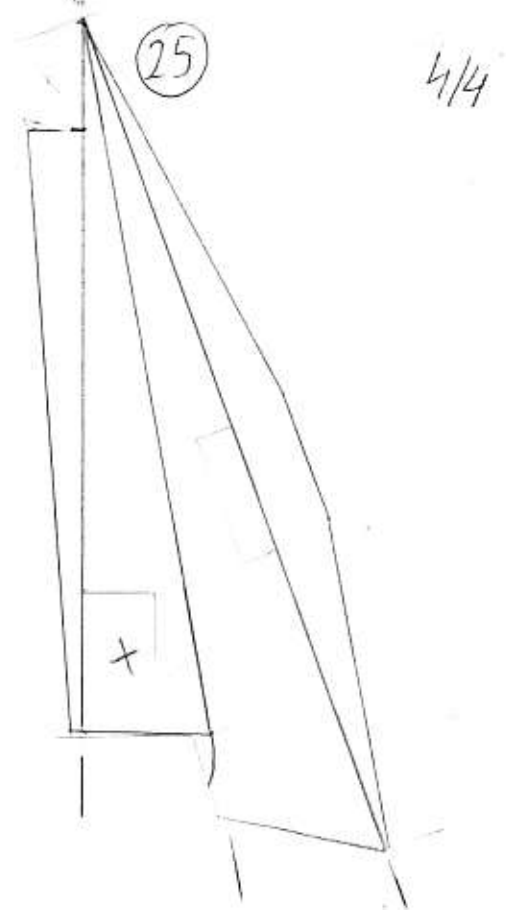



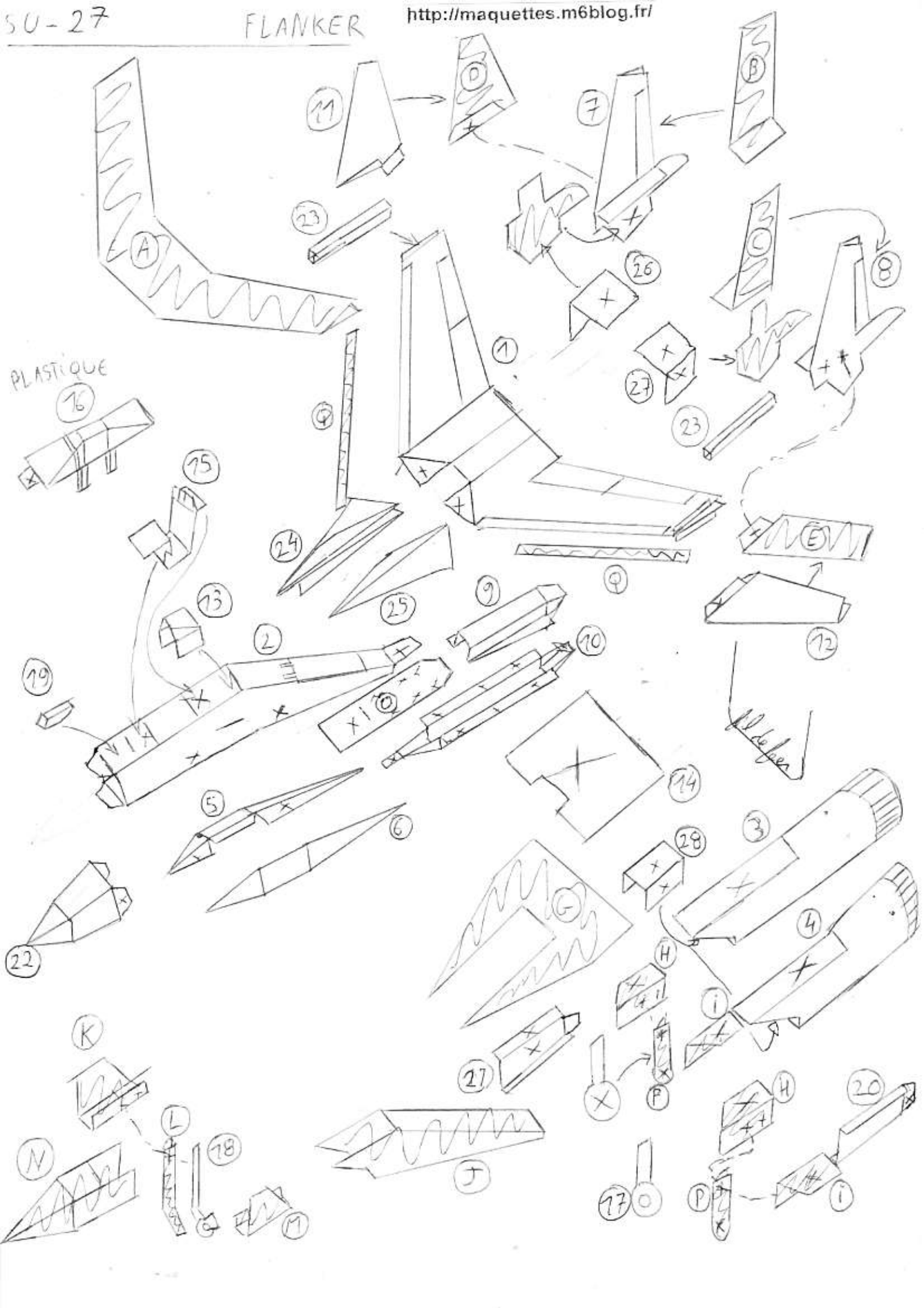

FLANKER

RENFORTS 1/2

