

15

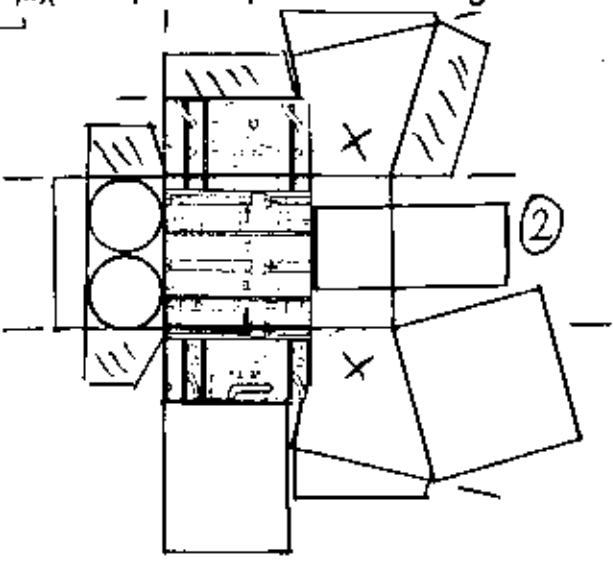

2

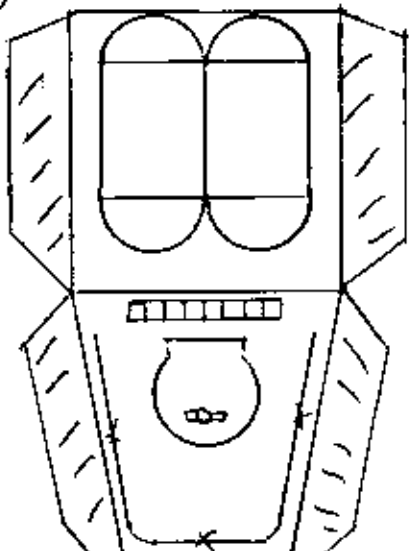
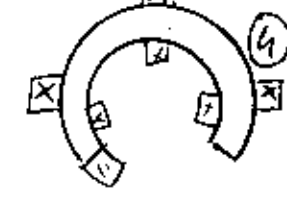
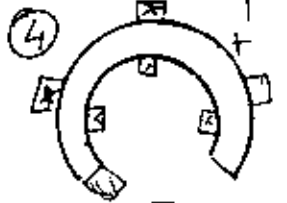
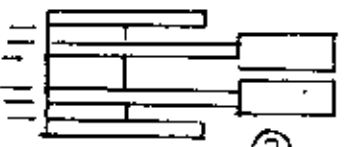

3

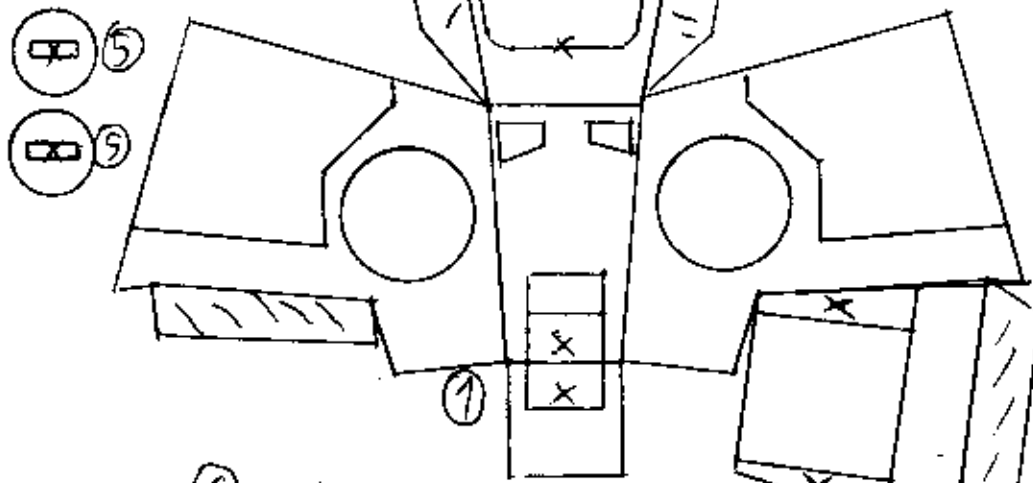

1

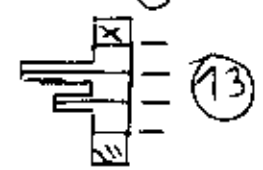

13

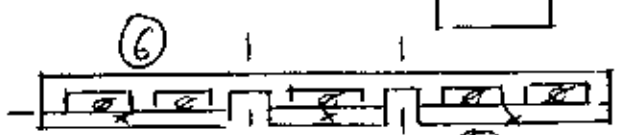

6

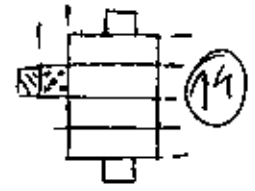

14

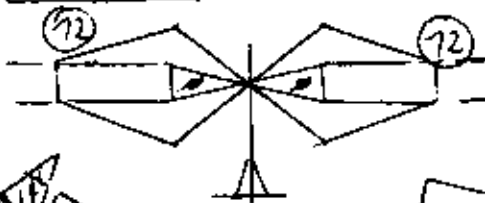

12

12

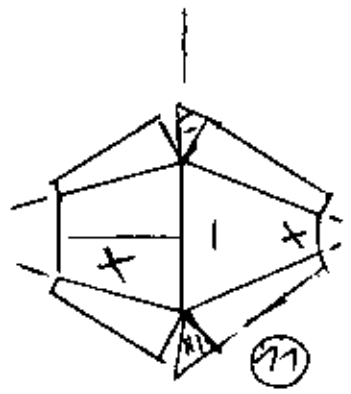

11

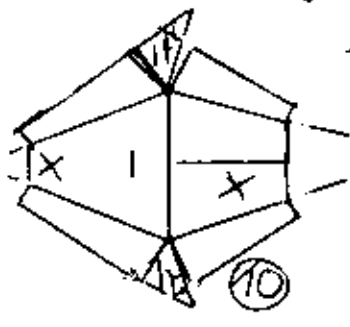

10

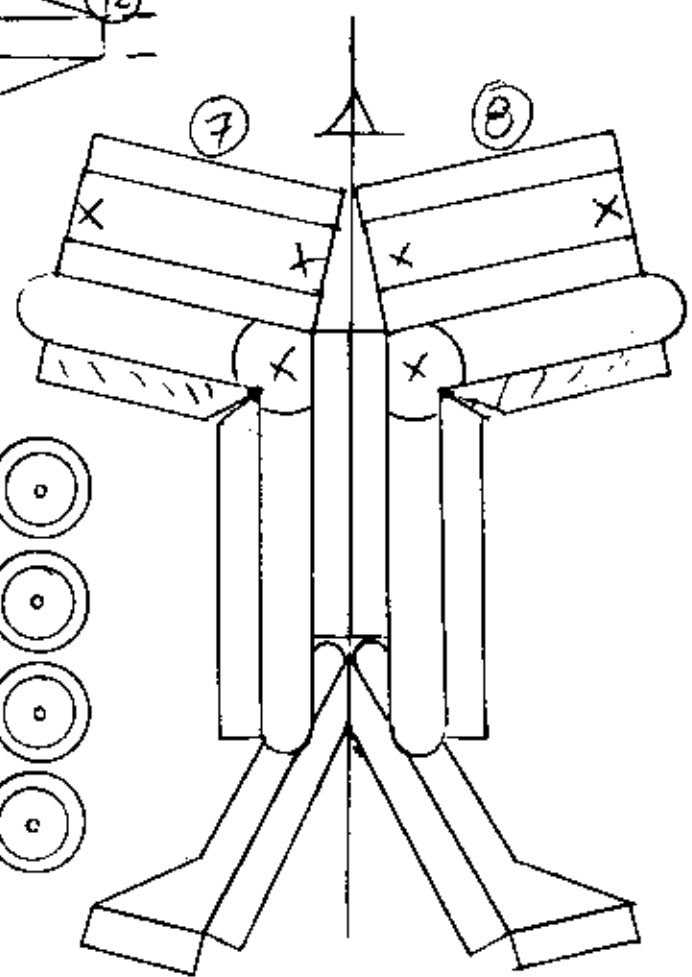

7

8

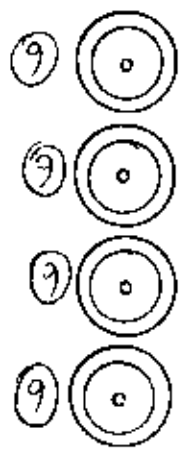

9

9

9

9

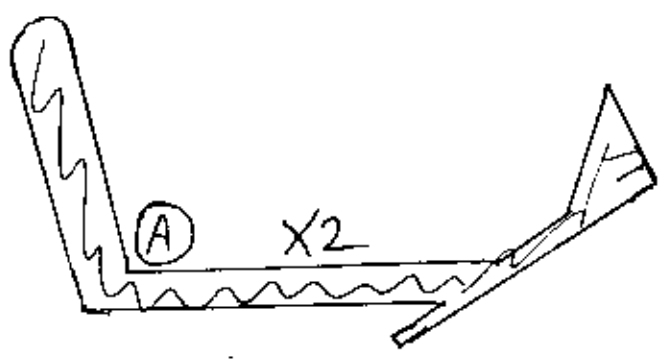

A

X2