

CHASSEUR / RECONNAISSANCE AVANCEE
MOYENNE PORTEE

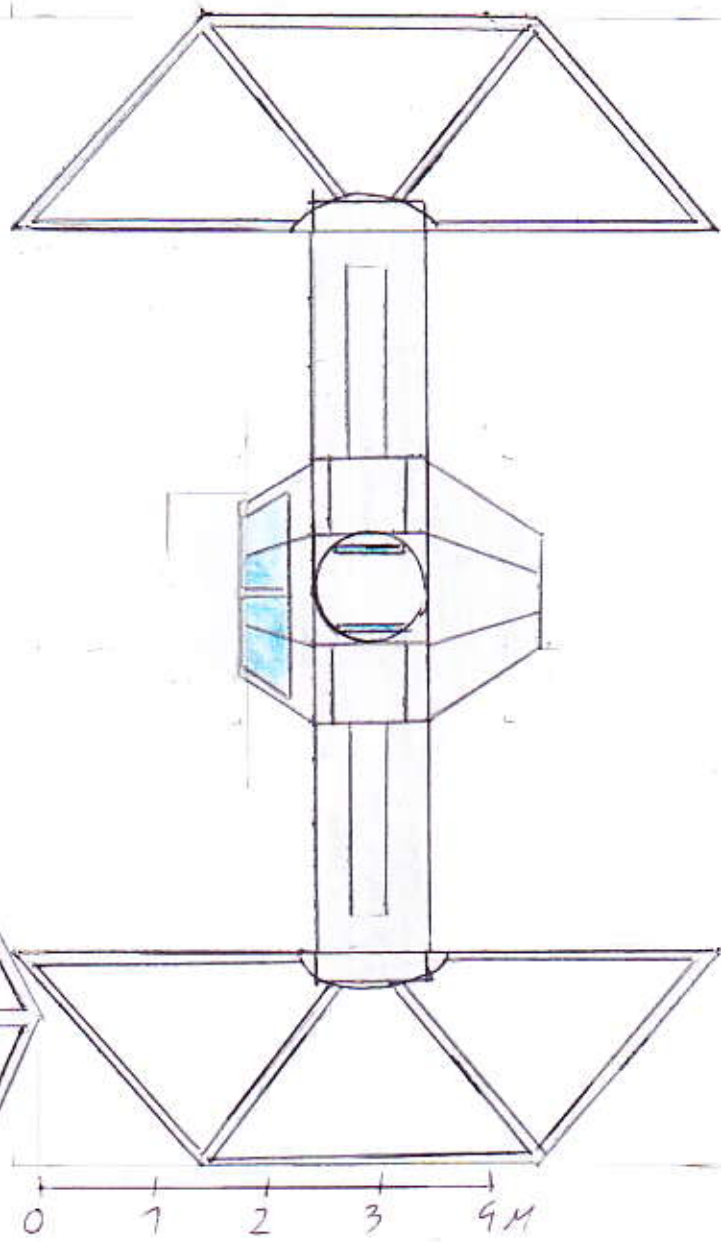

Tic
AVANT-GARDE

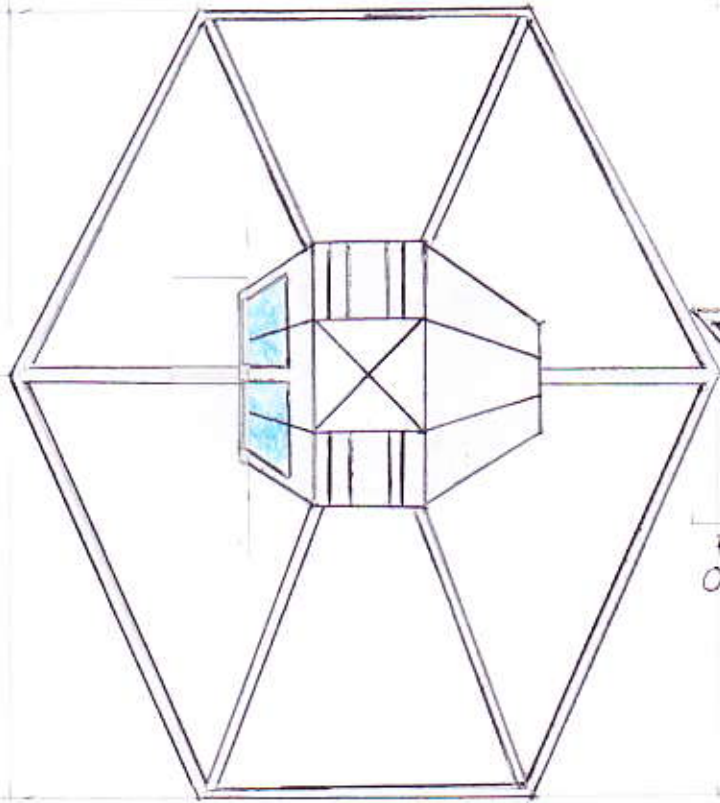
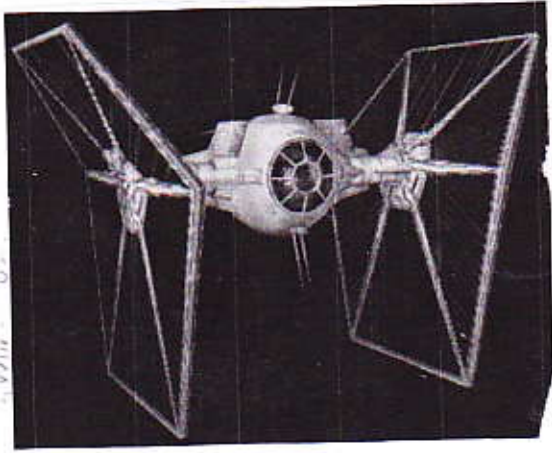
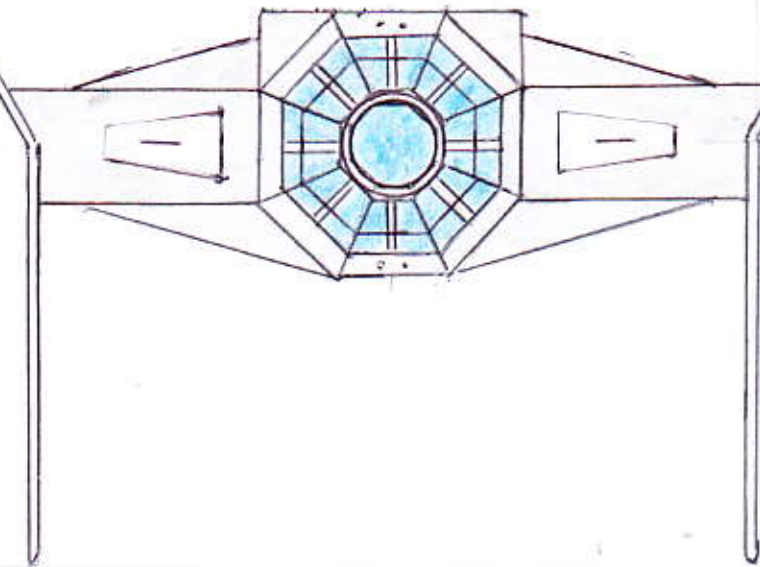

TIE AVANT-GARDE

RENFORTS BRAS

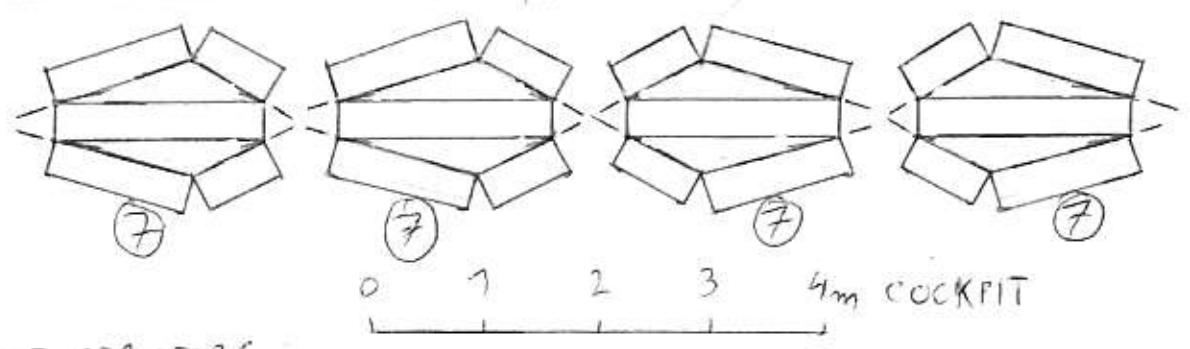

RENFORT STRUCTURE

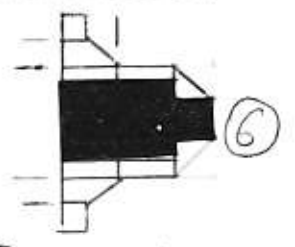
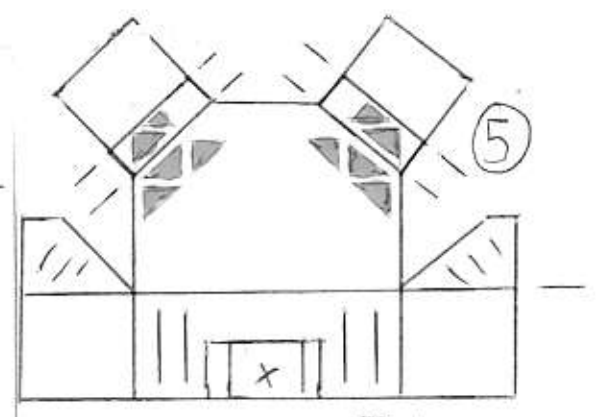
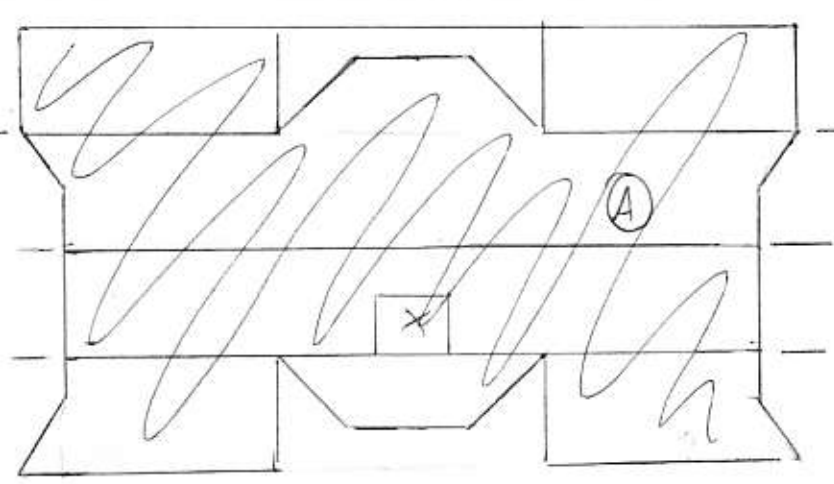

VERRIERE

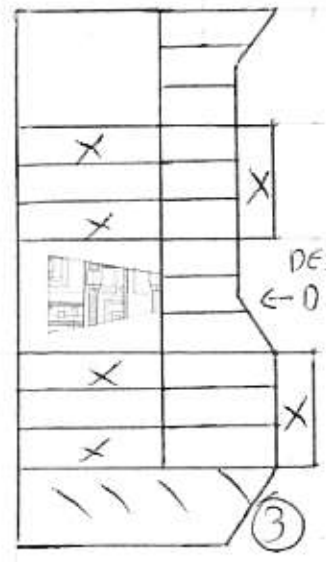
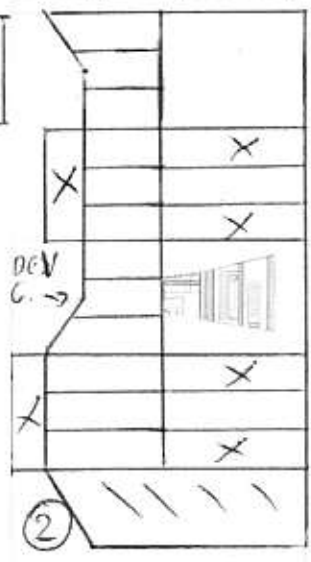
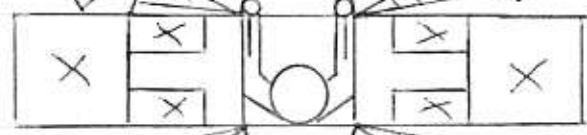
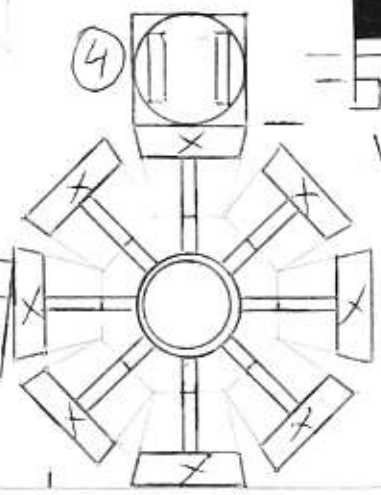
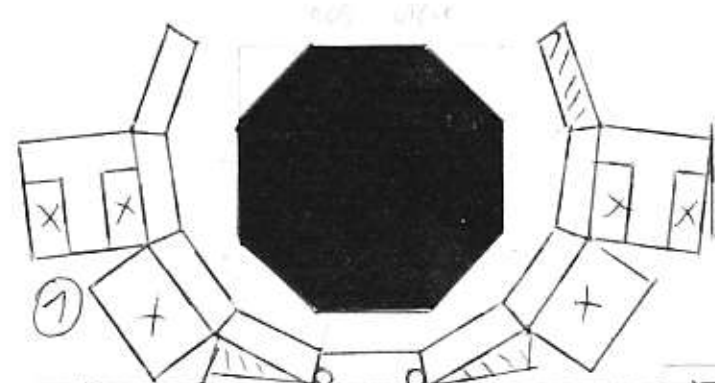

DEV
G. →

DEV
← 0.

TIE AVANT-GARDE

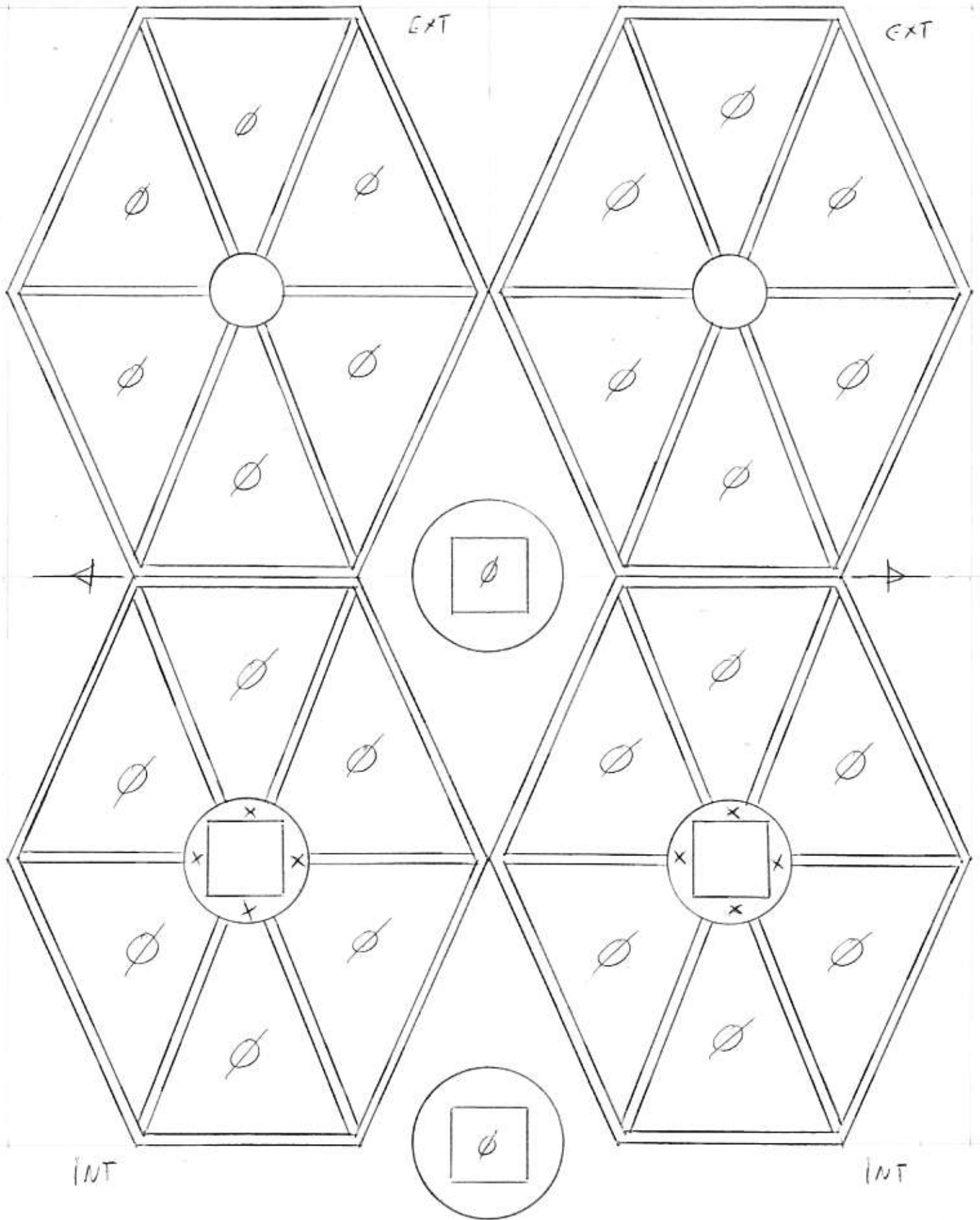
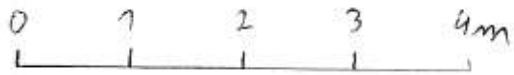

TIE AVANT-GARDE

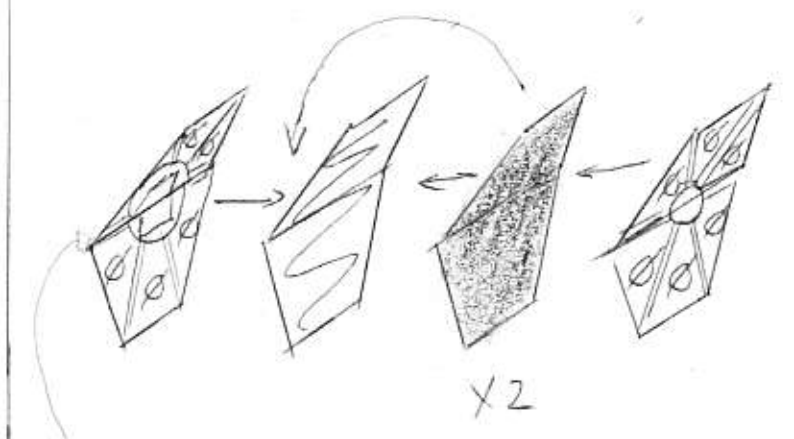
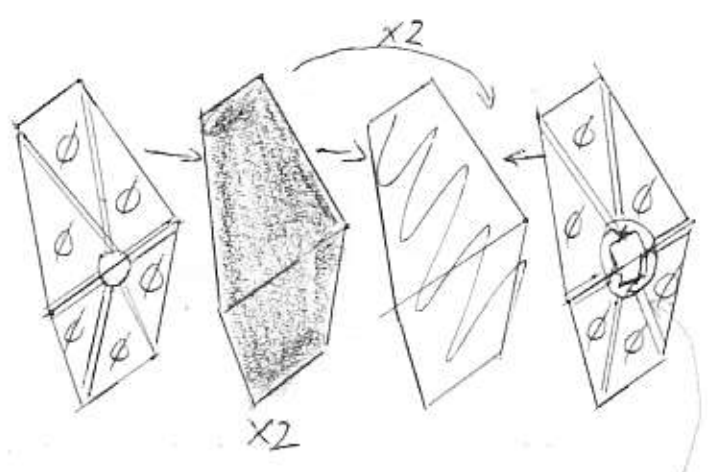

<http://maquettes.m6blog.fr/>

